

## Lecture 5

# Housing Markets and Kidney Exchange

Reminder about starting recording

# Housing Market

[Shapley and Scarf, *JME* 1974]

# Housing Market

[Shapley and Scarf, *JME* 1974]





# Housing Market

[Shapley and Scarf, *JME* 1974]



# Housing Market

[Shapley and Scarf, *JME* 1974]

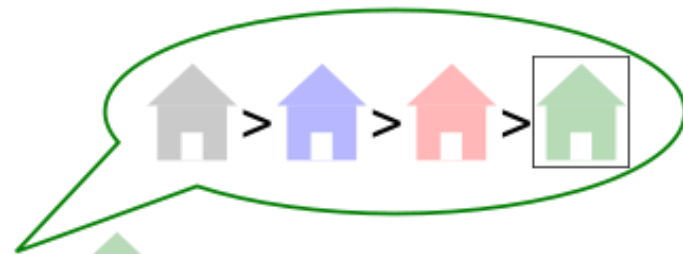
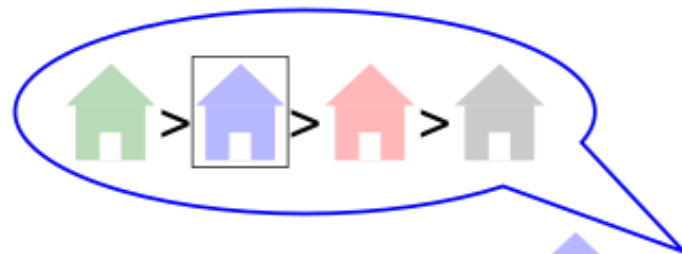
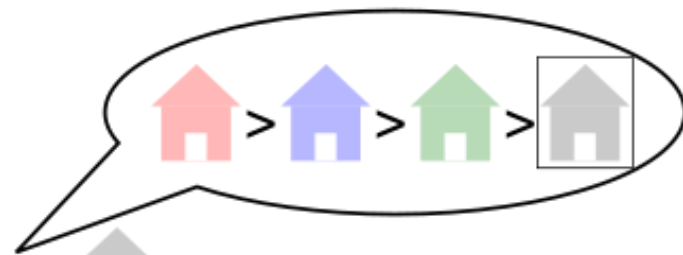
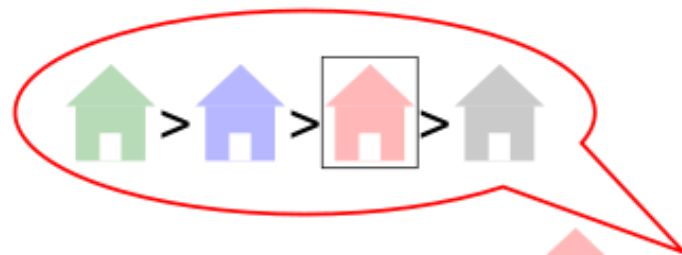

# Housing Market

[Shapley and Scarf, *JME* 1974]

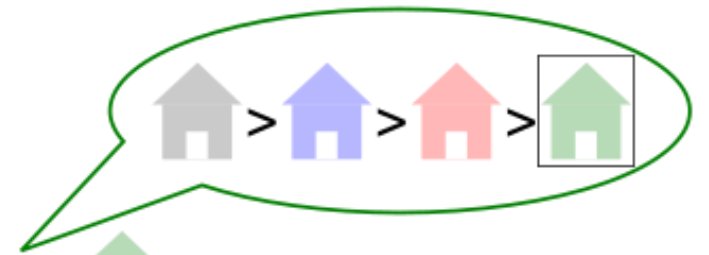
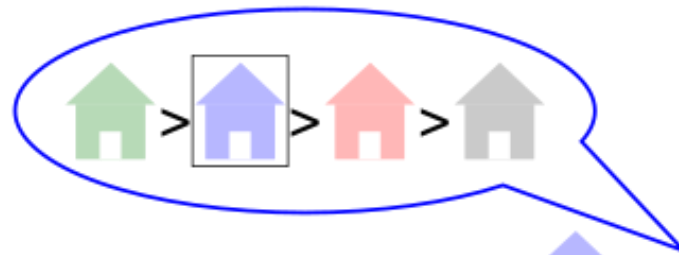
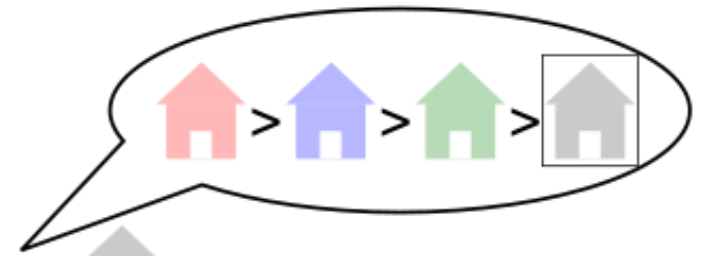
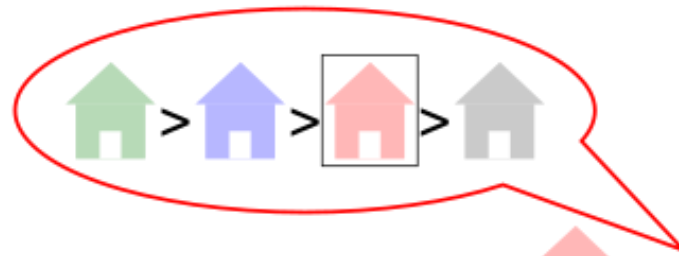

Can't use money. Only way to make agents happier is via *exchanges*.

# Housing Market

[Shapley and Scarf, *JME* 1974]

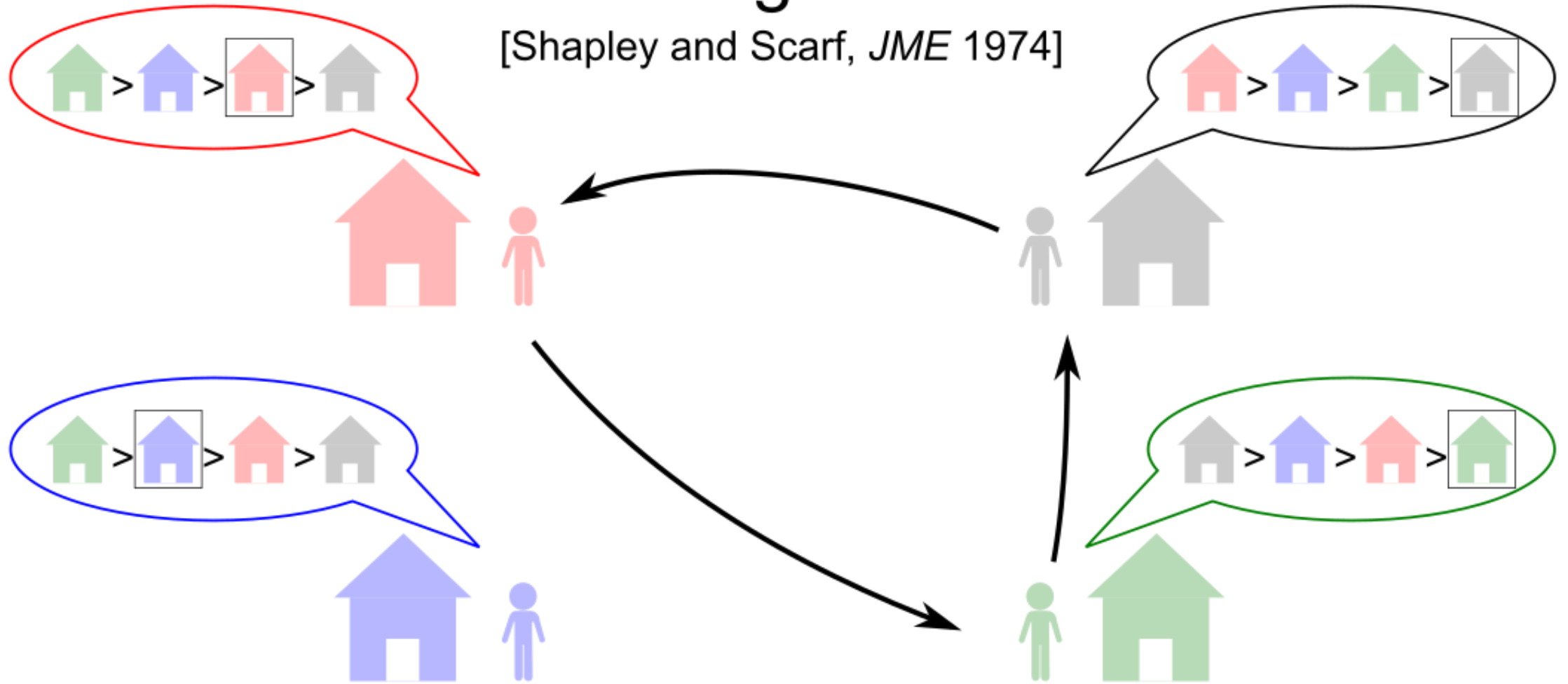

Can't use money. Only way to make agents happier is via *exchanges*.

# Housing Market

[Shapley and Scarf, *JME* 1974]

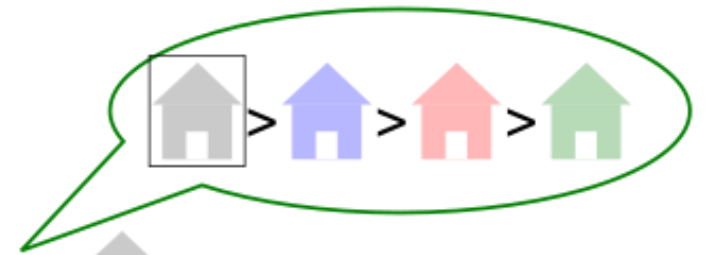
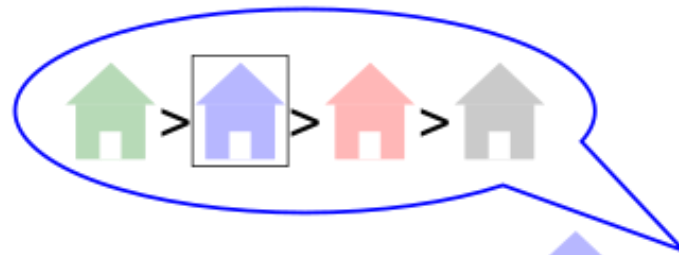
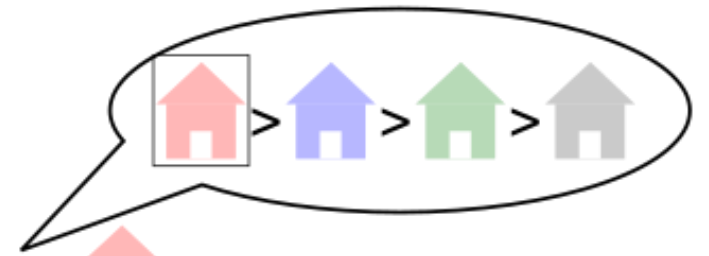
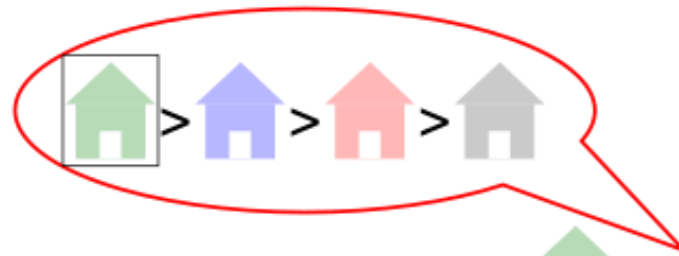

Can't use money. Only way to make agents happier is via *exchanges*.

# Housing Market

[Shapley and Scarf, *JME* 1974]

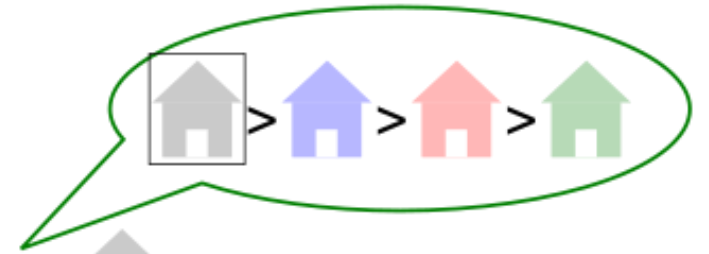
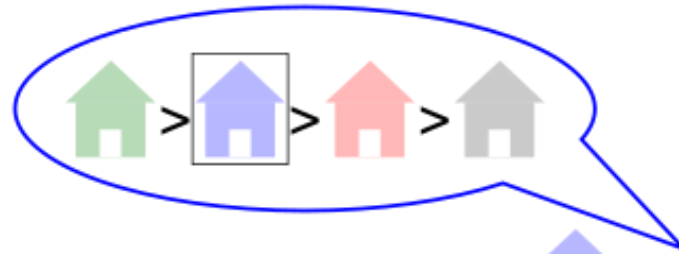
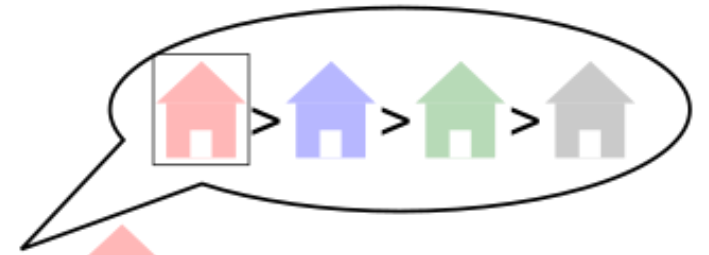
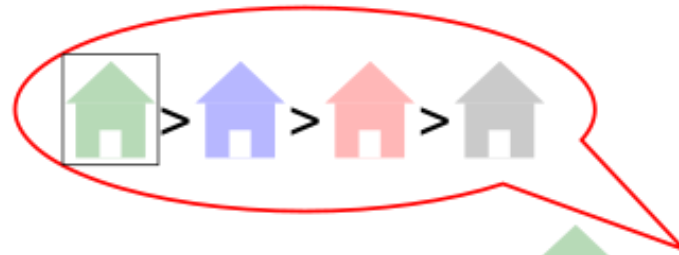

Is there a way to exchange houses to make the agents "maximally happy"?

# Top-Trading Cycle Algorithm (TTCA)

[Shapley and Scarf, *JME* 1974 (attributed to David Gale)]

# Top-Trading Cycle Algorithm (TTCA)

[Shapley and Scarf, *JME* 1974 (attributed to David Gale)]

While there is a remaining agent:

- Each remaining agent points to the owner of its favorite house.
- There must be a cycle (include self-loops). Do the cyclic exchange.
- Remove the agents and houses involved in the above exchange.



# Top-Trading Cycle Algorithm (TTCA)

[Shapley and Scarf, *JME* 1974 (attributed to David Gale)]

While there is a remaining agent:

- Each remaining agent points to the owner of its favorite house.
- There must be a cycle (include self-loops). Do the cyclic exchange.
- Remove the agents and houses involved in the above exchange.

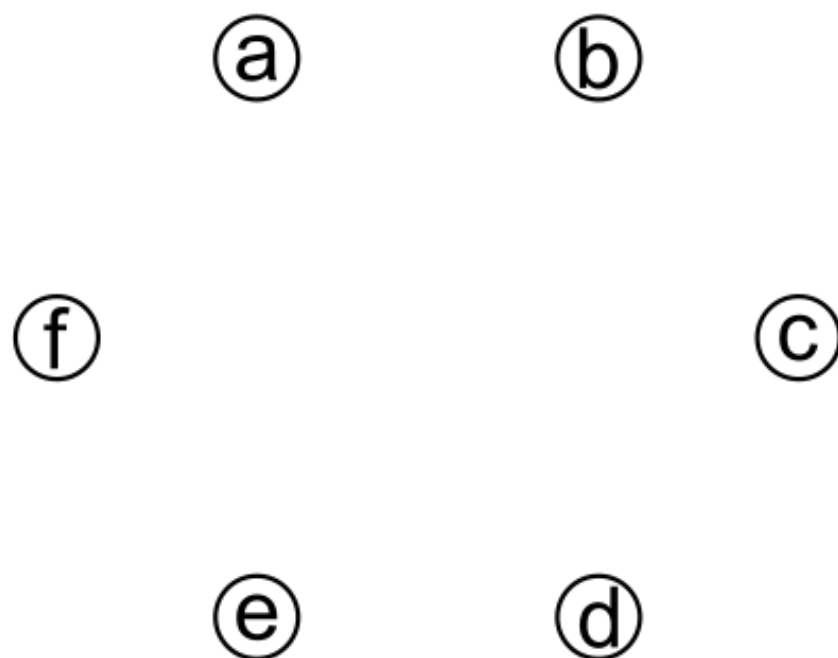

# Top-Trading Cycle Algorithm (TTCA)

[Shapley and Scarf, *JME* 1974 (attributed to David Gale)]

While there is a remaining agent:

- Each remaining agent points to the owner of its favorite house.
- There must be a cycle (include self-loops). Do the cyclic exchange.
- Remove the agents and houses involved in the above exchange.

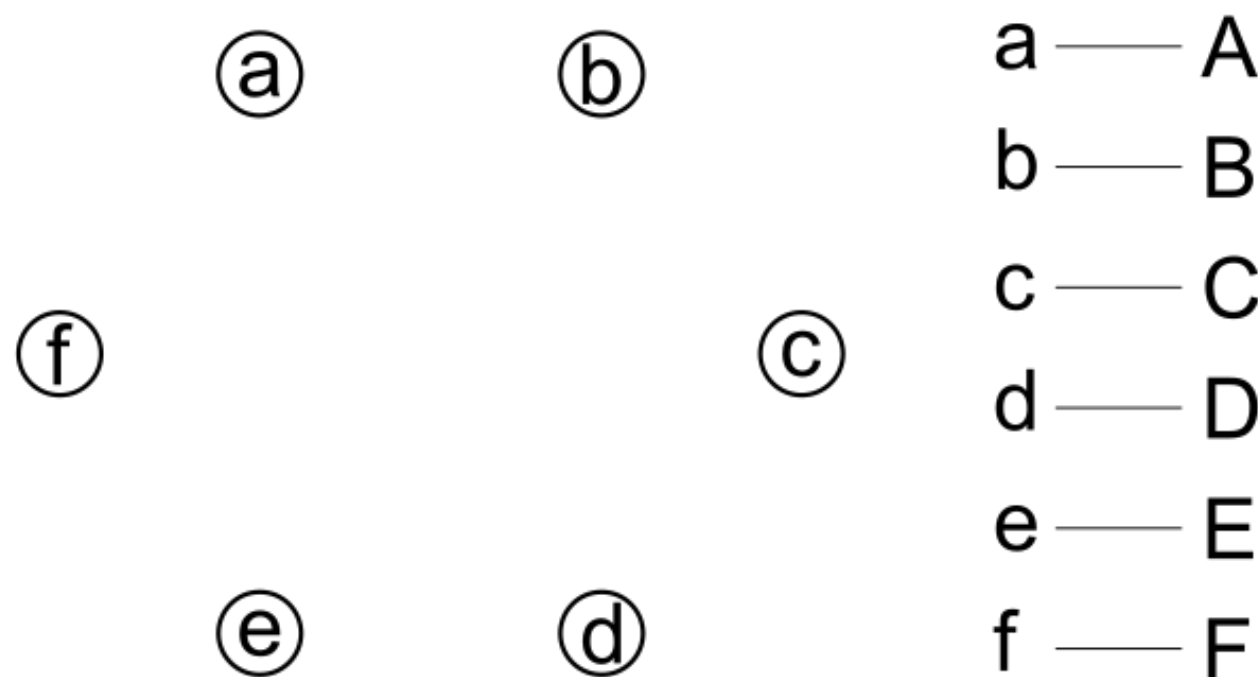

# Top-Trading Cycle Algorithm (TTCA)

[Shapley and Scarf, *JME* 1974 (attributed to David Gale)]

While there is a remaining agent:

- Each remaining agent points to the owner of its favorite house.
- There must be a cycle (include self-loops). Do the cyclic exchange.
- Remove the agents and houses involved in the above exchange.

	a	b	c	d	e	f				
1.	B	F	A	E	C	F	(a)	(b)	a — A	
2.									b — B	
3.				(f)				(c)	c — C	
4.									d — D	
5.									e — E	
6.					(e)			(d)	f — F	

# Top-Trading Cycle Algorithm (TTCA)

[Shapley and Scarf, *JME* 1974 (attributed to David Gale)]

While there is a remaining agent:

- Each remaining agent points to the owner of its favorite house.
- There must be a cycle (include self-loops). Do the cyclic exchange.
- Remove the agents and houses involved in the above exchange.

	a	b	c	d	e	f
1.	B	F	A	E	C	F
2.						
3.						
4.						
5.						
6.						

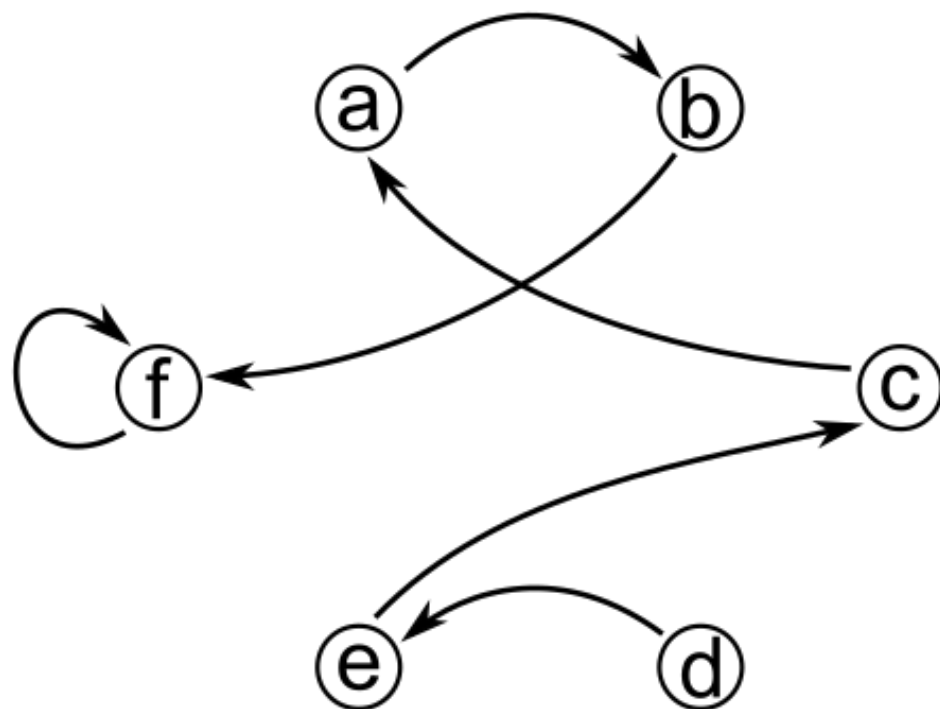

a	—	A
b	—	B
c	—	C
d	—	D
e	—	E
f	—	F

# Top-Trading Cycle Algorithm (TTCA)

[Shapley and Scarf, *JME* 1974 (attributed to David Gale)]

While there is a remaining agent:

- Each remaining agent points to the owner of its favorite house.
- There must be a cycle (include self-loops). Do the cyclic exchange.
- Remove the agents and houses involved in the above exchange.

	a	b	c	d	e	f
1.	B	F	A	E	C	F
2.						
3.						
4.						
5.						
6.						

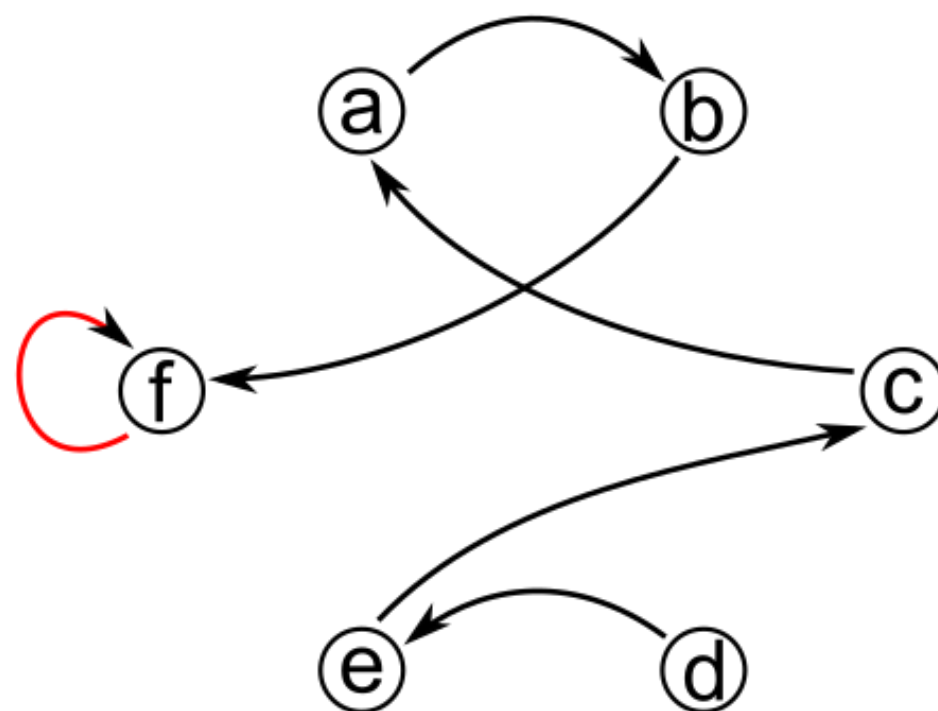

a	—	A
b	—	B
c	—	C
d	—	D
e	—	E
f	—	F

# Top-Trading Cycle Algorithm (TTCA)

[Shapley and Scarf, *JME* 1974 (attributed to David Gale)]

While there is a remaining agent:

- Each remaining agent points to the owner of its favorite house.
- There must be a cycle (include self-loops). Do the cyclic exchange.
- Remove the agents and houses involved in the above exchange.

	a	b	c	d	e	f
1.	B	F	A	E	C	F
2.						
3.						
4.						
5.						
6.						

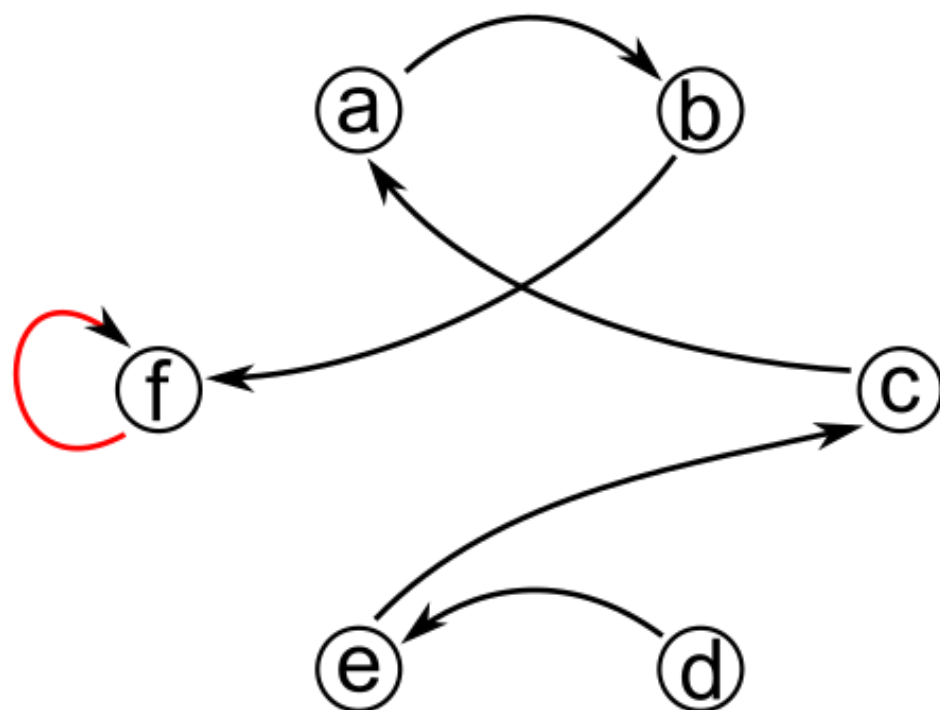

a	—	A
b	—	B
c	—	C
d	—	D
e	—	E
f	—	F



# Top-Trading Cycle Algorithm (TTCA)

[Shapley and Scarf, *JME* 1974 (attributed to David Gale)]

While there is a remaining agent:

- Each remaining agent points to the owner of its favorite house.
- There must be a cycle (include self-loops). Do the cyclic exchange.
- Remove the agents and houses involved in the above exchange.

	a	b	c	d	e
1.	B		A	E	C
2.					
3.					
4.					
5.					
6.					

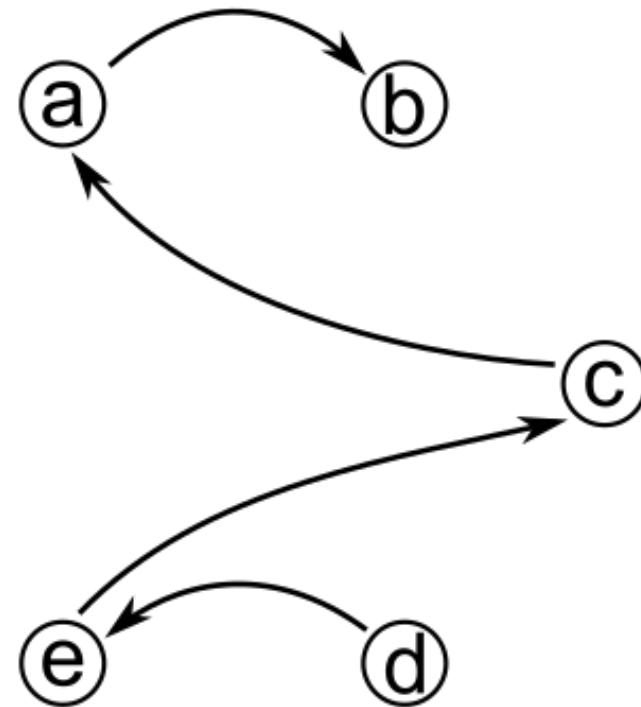

a	—	A
b	—	B
c	—	C
d	—	D
e	—	E
f	—	F

# Top-Trading Cycle Algorithm (TTCA)

[Shapley and Scarf, *JME* 1974 (attributed to David Gale)]

While there is a remaining agent:

- Each remaining agent points to the owner of its favorite house.
- There must be a cycle (include self-loops). Do the cyclic exchange.
- Remove the agents and houses involved in the above exchange.

	a	b	c	d	e
1.	B		A	E	C
2.		C			
3.					
4.					
5.					
6.					

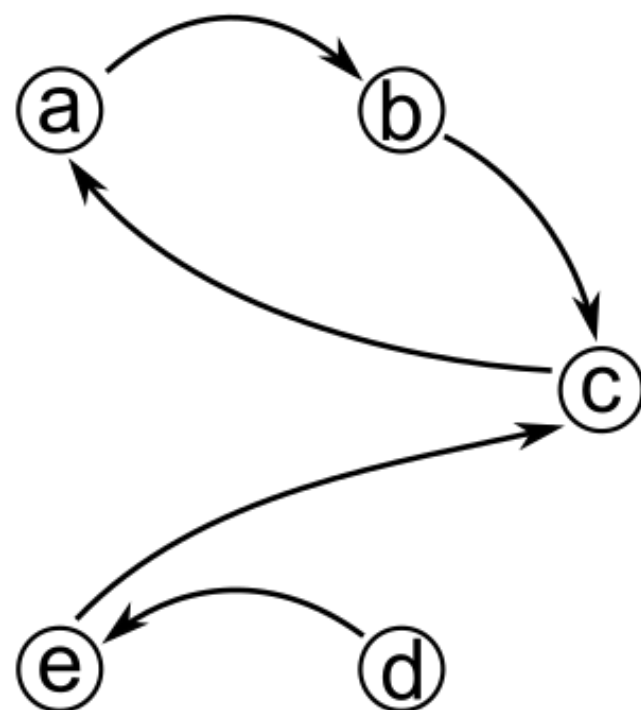

a	—	A
b	—	B
c	—	C
d	—	D
e	—	E
f	—	F



# Top-Trading Cycle Algorithm (TTCA)

[Shapley and Scarf, *JME* 1974 (attributed to David Gale)]

While there is a remaining agent:

- Each remaining agent points to the owner of its favorite house.
- There must be a cycle (include self-loops). Do the cyclic exchange.
- Remove the agents and houses involved in the above exchange.

	a	b	c	d	e
1.	B		A	E	C
2.		C			
3.					
4.					
5.					
6.					

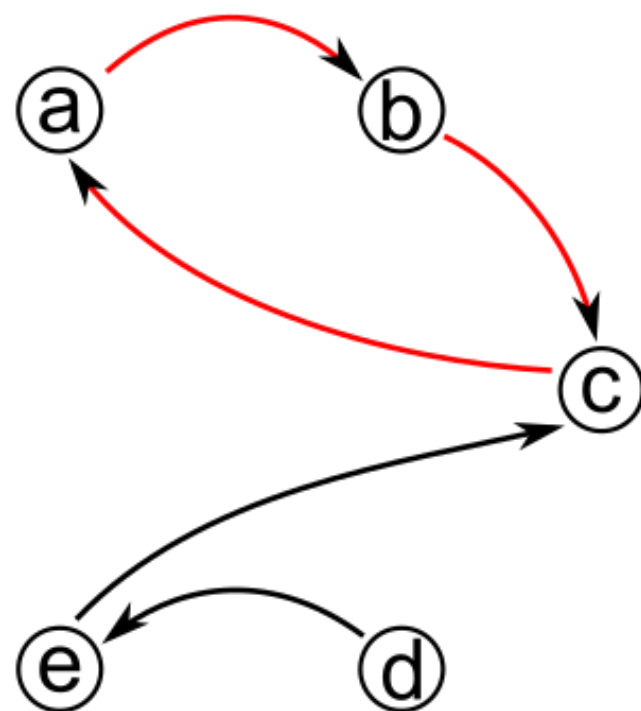

a	—	A
b	—	B
c	—	C
d	—	D
e	—	E
f	—	F

# Top-Trading Cycle Algorithm (TTCA)

[Shapley and Scarf, *JME* 1974 (attributed to David Gale)]

While there is a remaining agent:

- Each remaining agent points to the owner of its favorite house.
- There must be a cycle (include self-loops). Do the cyclic exchange.
- Remove the agents and houses involved in the above exchange.

	a	b	c	d	e
1.	B		A	E	C
2.		C			
3.					
4.					
5.					
6.					

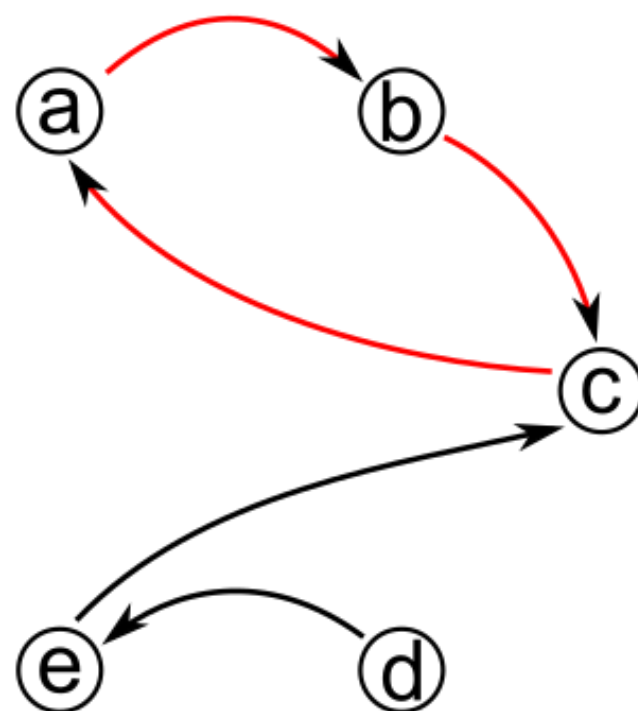

a	—	B
b	—	C
c	—	A
d	—	D
e	—	E
f	—	F

# Top-Trading Cycle Algorithm (TTCA)

[Shapley and Scarf, *JME* 1974 (attributed to David Gale)]

While there is a remaining agent:

- Each remaining agent points to the owner of its favorite house.
- There must be a cycle (include self-loops). Do the cyclic exchange.
- Remove the agents and houses involved in the above exchange.

		d	e
1.	_____	E	
2.			
3.			
4.			
5.			
6.			

a	—	B
b	—	C
c	—	A
d	—	D
e	—	E
f	—	F



# Top-Trading Cycle Algorithm (TTCA)

[Shapley and Scarf, *JME* 1974 (attributed to David Gale)]

While there is a remaining agent:

- Each remaining agent points to the owner of its favorite house.
- There must be a cycle (include self-loops). Do the cyclic exchange.
- Remove the agents and houses involved in the above exchange.

		d	e
1.	_____	E	
2.			
3.			
4.		D	
5.			
6.		E	

a	—	B
b	—	C
c	—	A
d	—	D
e	—	E
f	—	F



# Top-Trading Cycle Algorithm (TTCA)

[Shapley and Scarf, *JME* 1974 (attributed to David Gale)]

While there is a remaining agent:

- Each remaining agent points to the owner of its favorite house.
- There must be a cycle (include self-loops). Do the cyclic exchange.
- Remove the agents and houses involved in the above exchange.

		d	e
1.	_____	E	
2.			
3.			
4.		D	
5.			
6.		E	

a	—	B
b	—	C
c	—	A
d	—	D
e	—	E
f	—	F



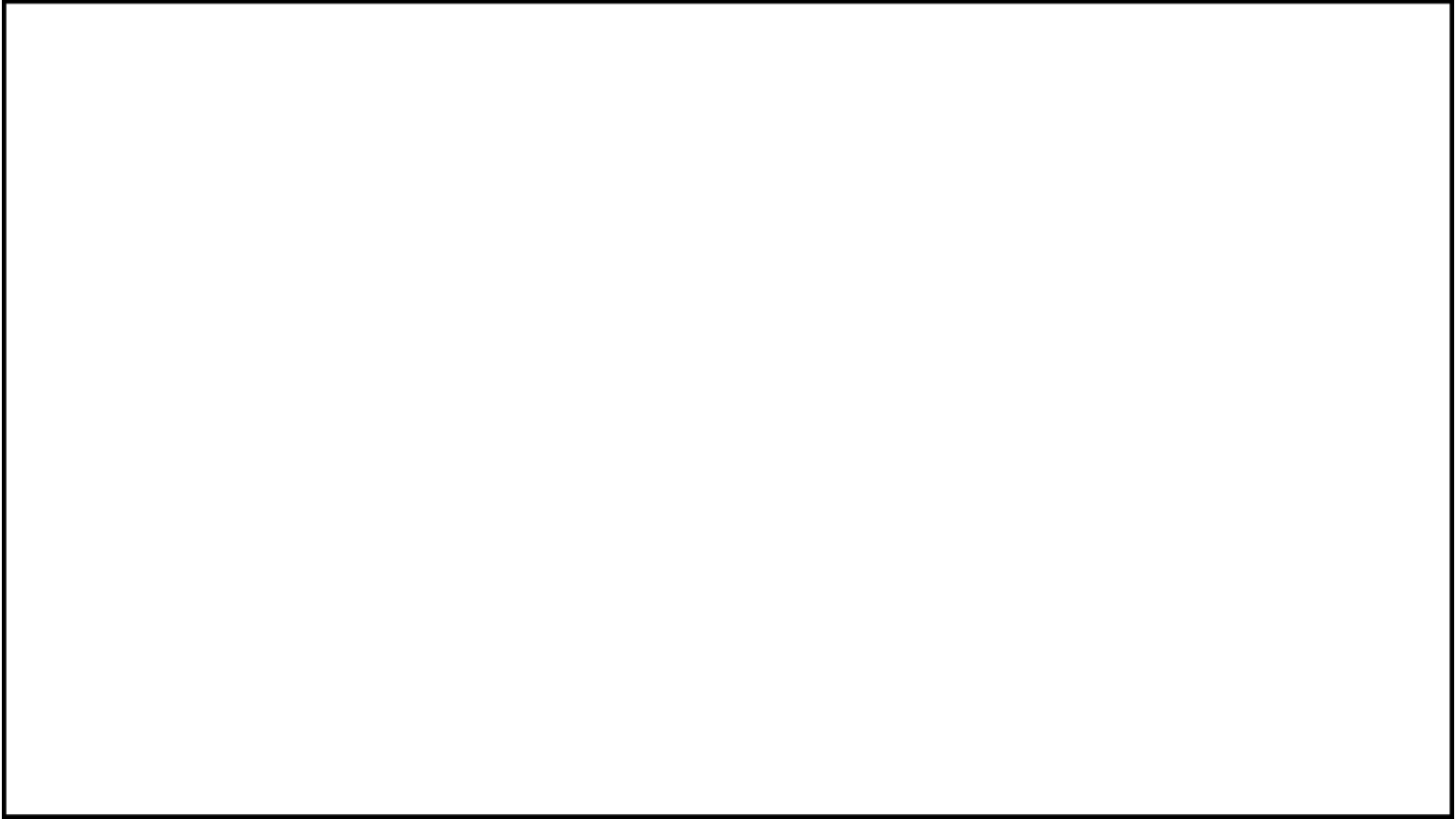

Q1. Is a cyclic exchange always possible?

Q1. Is a cyclic exchange always possible? Yes.

Imagine a graph where the *vertices* are the (remaining) agents and the *edge*  $i \rightarrow j$  means that agent  $i$ 's favorite house is owned by agent  $j$ .

At each step, each vertex has an outgoing edge.

With finitely many vertices, there must exist a cycle.



Q1. Is a cyclic exchange always possible? Yes.

Imagine a graph where the *vertices* are the (remaining) agents and the *edge*  $i \rightarrow j$  means that agent  $i$ 's favorite house is owned by agent  $j$ .

At each step, each vertex has an outgoing edge.

With finitely many vertices, there must exist a cycle.

Q2. Does TTCA always terminate?

Q1. **Is a cyclic exchange always possible?** Yes.

Imagine a graph where the *vertices* are the (remaining) agents and the *edge*  $i \rightarrow j$  means that agent  $i$ 's favorite house is owned by agent  $j$ .

At each step, each vertex has an outgoing edge.

With finitely many vertices, there must exist a cycle.

Q2. **Does TTCA always terminate?** Yes.

At least one agent kicked out in each round.

Q1. **Is a cyclic exchange always possible?** Yes.

Imagine a graph where the *vertices* are the (remaining) agents and the *edge*  $i \rightarrow j$  means that agent  $i$ 's favorite house is owned by agent  $j$ .

At each step, each vertex has an outgoing edge.

With finitely many vertices, there must exist a cycle.

Q2. **Does TTCA always terminate?** Yes.

At least one agent kicked out in each round.

Q3. **Does TTCA terminate in polynomial time?**

Q1. **Is a cyclic exchange always possible?** Yes.

Imagine a graph where the *vertices* are the (remaining) agents and the *edge*  $i \rightarrow j$  means that agent  $i$ 's favorite house is owned by agent  $j$ .

At each step, each vertex has an outgoing edge.

With finitely many vertices, there must exist a cycle.

Q2. **Does TTCA always terminate?** Yes.

At least one agent kicked out in each round.

Q3. **Does TTCA terminate in polynomial time?** Yes.

# TTCA is strategyproof

[Roth, *Econ. Letters* 1982]

# TTCA is strategyproof

[Roth, *Econ. Letters* 1982]

Let  $S_k$  denote the set of agents who are removed in round  $k$  of TTCA.

# TTCA is strategyproof

[Roth, *Econ. Letters* 1982]

Let  $S_k$  denote the set of agents who are removed in round  $k$  of TTCA.

$S_1$



$S_2$



# TTCA is strategyproof

[Roth, *Econ. Letters* 1982]

Let  $S_k$  denote the set of agents who are removed in round  $k$  of TTCA.

Each agent in  $S_1$  gets its favorite house and therefore has no incentive to misreport.

$S_1$



$S_2$





# TTCA is strategyproof

[Roth, *Econ. Letters* 1982]

Let  $S_k$  denote the set of agents who are removed in round  $k$  of TTCA.

Each agent in  $S_1$  gets its favorite house and therefore has no incentive to misreport.

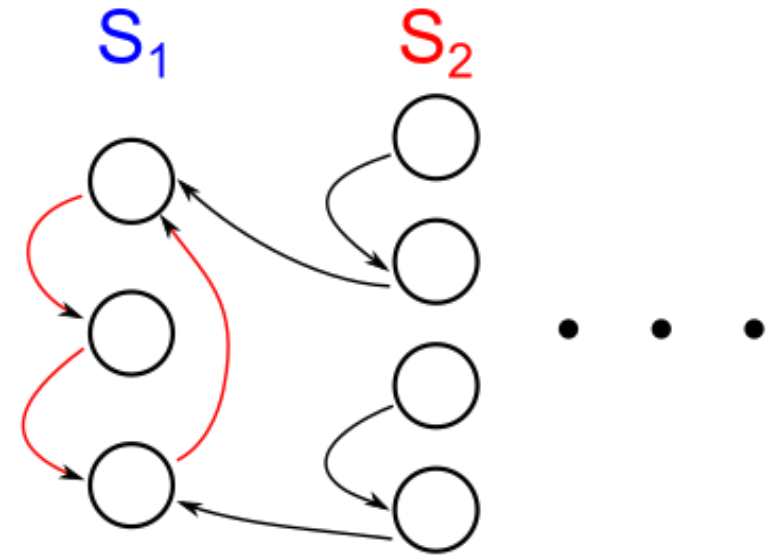

# TTCA is strategyproof

[Roth, *Econ. Letters* 1982]

Let  $S_k$  denote the set of agents who are removed in round  $k$  of TTCA.

Each agent in  $S_1$  gets its favorite house and therefore has no incentive to misreport.

Subject to that, no agent in  $S_2$  has any incentive to misreport.

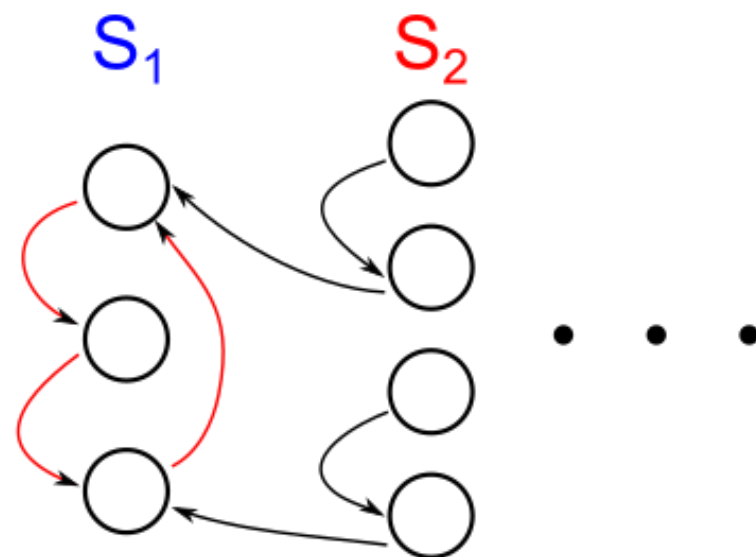

# TTCA is strategyproof

[Roth, *Econ. Letters* 1982]

Let  $S_k$  denote the set of agents who are removed in round  $k$  of TTCA.

Each agent in  $S_1$  gets its favorite house and therefore has no incentive to misreport.

Subject to that, no agent in  $S_2$  has any incentive to misreport.

- No agent in  $S_2$  can get a house owned by an agent in  $S_1$  since, in round 1, no agent in  $S_1$  points to an agent in  $S_2$ .

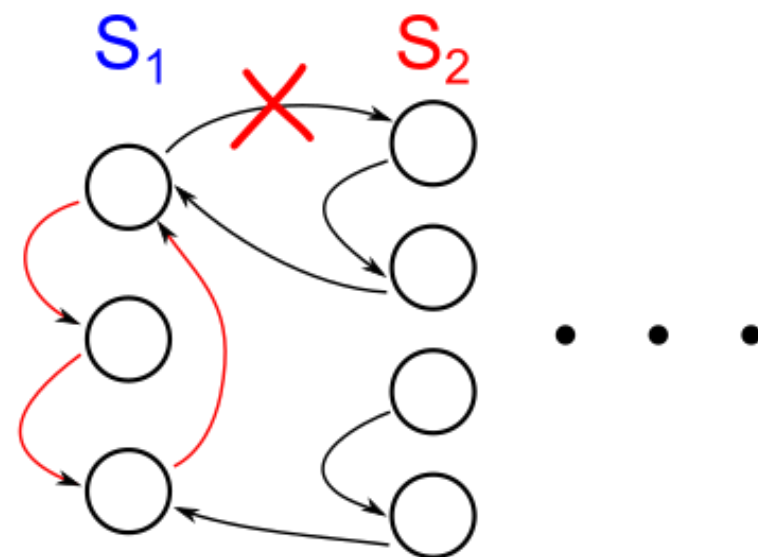

# TTCA is strategyproof

[Roth, *Econ. Letters* 1982]

Let  $S_k$  denote the set of agents who are removed in round  $k$  of TTCA.

Each agent in  $S_1$  gets its favorite house and therefore has no incentive to misreport.

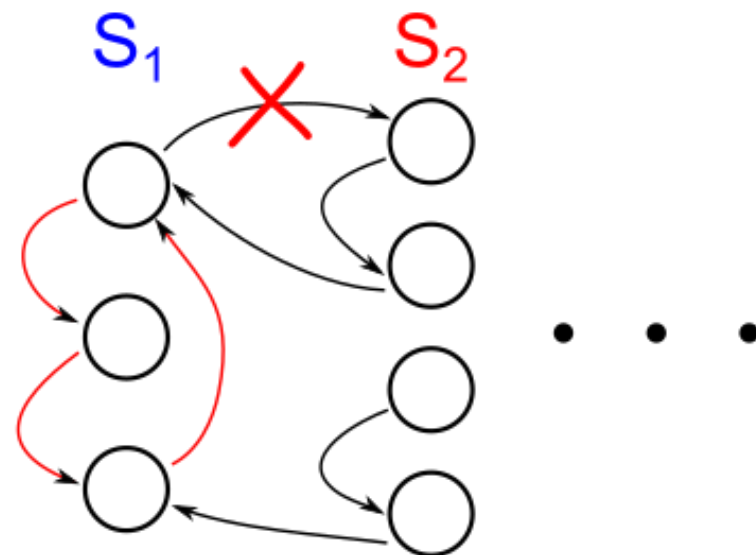

Subject to that, no agent in  $S_2$  has any incentive to misreport.

- No agent in  $S_2$  can get a house owned by an agent in  $S_1$  since, in round 1, no agent in  $S_1$  points to an agent in  $S_2$ .
- So, each agent in  $S_2$  gets its favorite house among the remaining ones.

# TTCA is strategyproof

[Roth, *Econ. Letters* 1982]

Let  $S_k$  denote the set of agents who are removed in round  $k$  of TTCA.

Each agent in  $S_1$  gets its favorite house and therefore has no incentive to misreport.

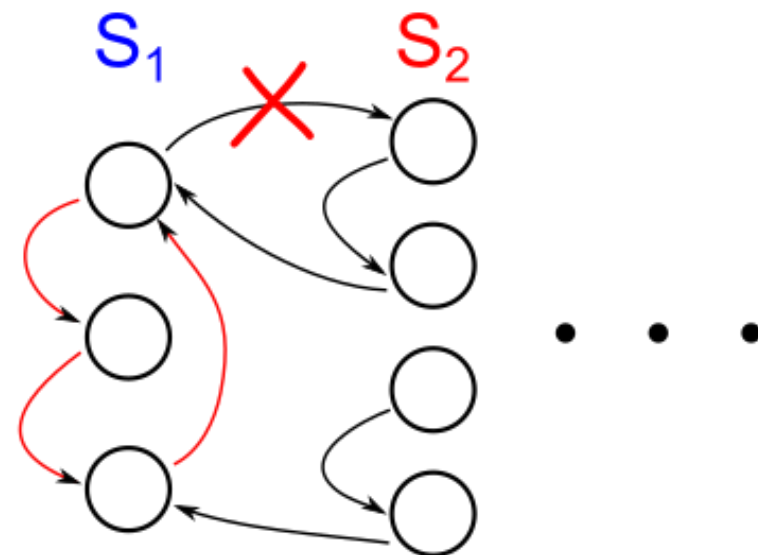

Subject to that, no agent in  $S_2$  has any incentive to misreport.

- No agent in  $S_2$  can get a house owned by an agent in  $S_1$  since, in round 1, no agent in  $S_1$  points to an agent in  $S_2$ .
- So, each agent in  $S_2$  gets its favorite house among the remaining ones.

Use induction.

# TTCA is strategyproof

[Roth, *Econ. Letters* 1982]

Let  $S_k$  denote the set of agents who are removed in round  $k$  of TTCA.

Each agent in  $S_1$  gets its favorite house and therefore has no incentive to misreport.

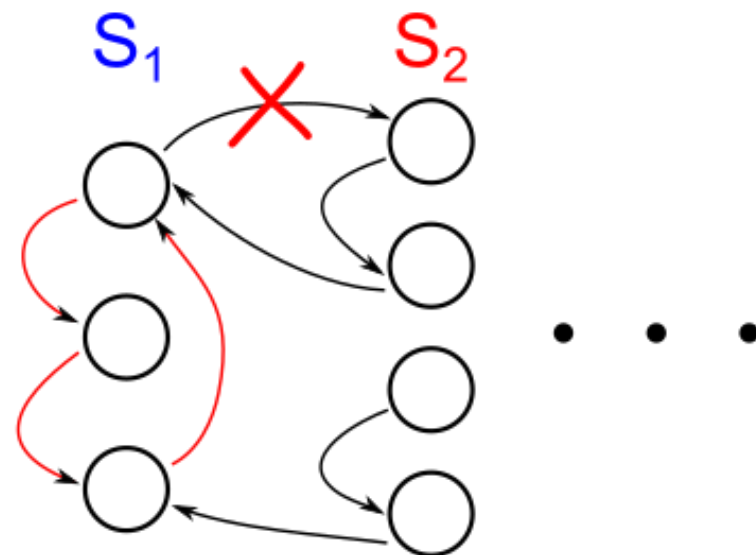

Subject to that, no agent in  $S_2$  has any incentive to misreport.

- No agent in  $S_2$  can get a house owned by an agent in  $S_1$  since, in round 1, no agent in  $S_1$  points to an agent in  $S_2$ .
- So, each agent in  $S_2$  gets its favorite house among the remaining ones.

Use induction. ■



# The Core

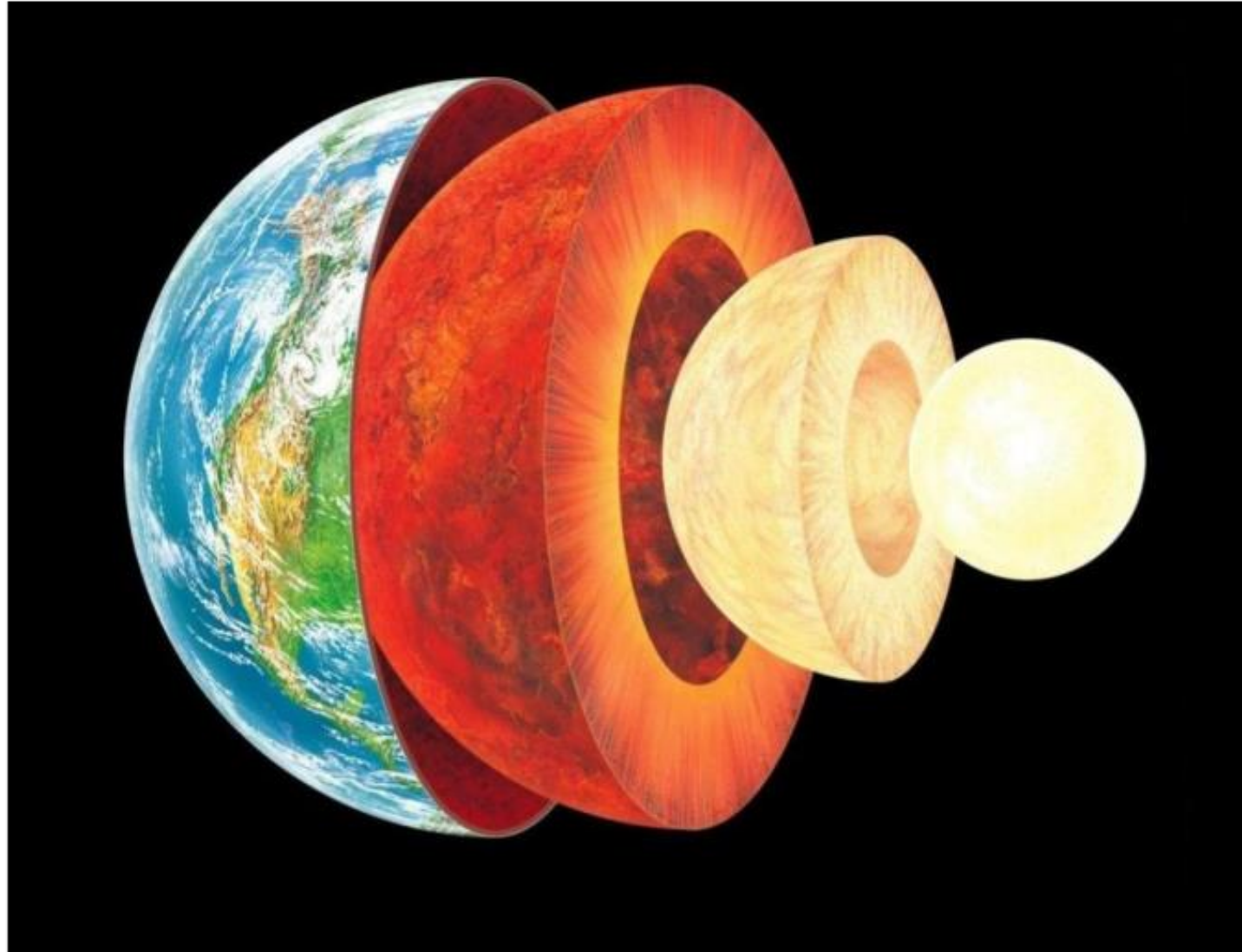

# The Core

An allocation is in the *core* if no subset of agents can break away from it, reallocate houses among themselves, and all be strictly better off.

That is, there is no "blocking coalition".



**TTCA outcome is in the core.**

[Shapley and Scarf, *JME* 1974 (attributed to David Gale)]

# TTCA outcome is in the core.

[Shapley and Scarf, *JME* 1974 (attributed to David Gale)]

Suppose, for contradiction, that a set **B** of agents can break away from the TTCA outcome and improve by internal reallocation.

# TTCA outcome is in the core.

[Shapley and Scarf, *JME* 1974 (attributed to David Gale)]

Suppose, for contradiction, that a set **B** of agents can break away from the TTCA outcome and improve by internal reallocation.

Among the agents in **B**, suppose the first one to be removed during TTCA is agent **b** (and suppose **b** is removed in round  $k$ ).

# TTCA outcome is in the core.

[Shapley and Scarf, *JME* 1974 (attributed to David Gale)]

Suppose, for contradiction, that a set **B** of agents can break away from the TTCA outcome and improve by internal reallocation.

Among the agents in **B**, suppose the first one to be removed during TTCA is agent **b** (and suppose **b** is removed in round  $k$ ).

Since all agents in **B** are removed in round  $k$  or later, the houses owned by agents in **B** are still available at the start of round  $k$ .

# TTCA outcome is in the core.

[Shapley and Scarf, *JME* 1974 (attributed to David Gale)]

Suppose, for contradiction, that a set  $B$  of agents can break away from the TTCA outcome and improve by internal reallocation.

Among the agents in  $B$ , suppose the first one to be removed during TTCA is agent  $b$  (and suppose  $b$  is removed in round  $k$ ).

Since all agents in  $B$  are removed in round  $k$  or later, the houses owned by agents in  $B$  are still available at the start of round  $k$ .

Agent  $b$  gets its favorite house among those available at the start of round  $k$ . Therefore,  $b$  cannot improve by reallocation of houses among agents in  $B$ .

# TTCA outcome is in the core.

[Shapley and Scarf, *JME* 1974 (attributed to David Gale)]

Suppose, for contradiction, that a set  $B$  of agents can break away from the TTCA outcome and improve by internal reallocation.

Among the agents in  $B$ , suppose the first one to be removed during TTCA is agent  $b$  (and suppose  $b$  is removed in round  $k$ ).

Since all agents in  $B$  are removed in round  $k$  or later, the houses owned by agents in  $B$  are still available at the start of round  $k$ .

Agent  $b$  gets its favorite house among those available at the start of round  $k$ . Therefore,  $b$  cannot improve by reallocation of houses among agents in  $B$ .



# TTCA outcome is in the core.

[Shapley and Scarf, *JME* 1974 (attributed to David Gale)]

In fact, TTCA recovers the **unique** core outcome.

[Discuss on Teams channel or on Piazza]









# Application of TTCA

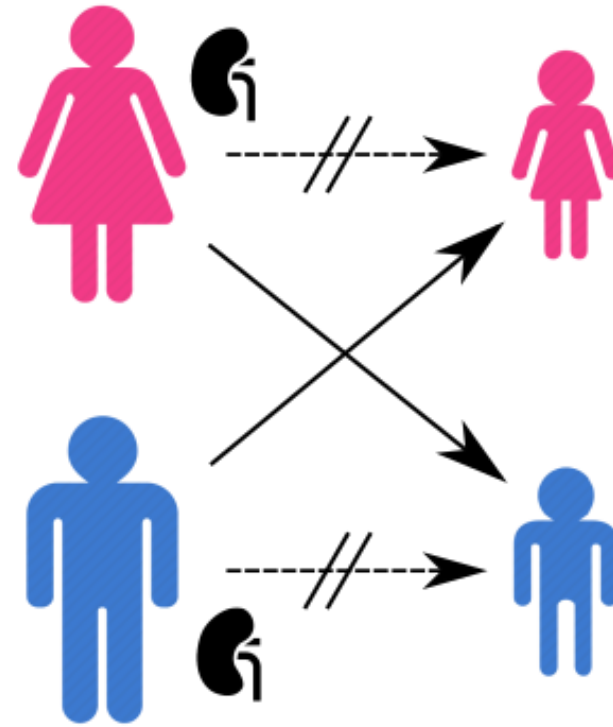

# Kidney Exchange

# Kidney Exchange

Many people suffer from kidney failure  
(waiting list in US: ~90,000; in India: ~200,000).

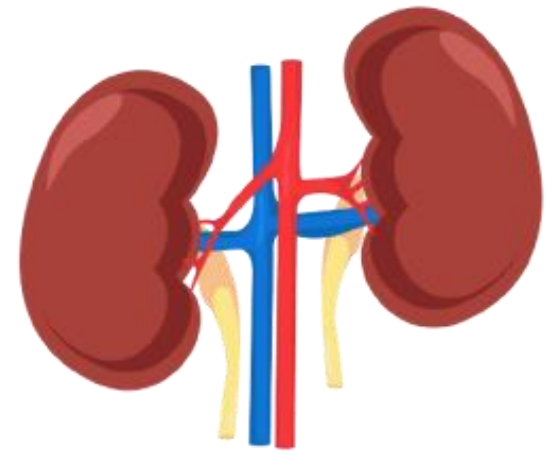

# Kidney Exchange

Many people suffer from kidney failure  
(waiting list in US: ~90,000; in India: ~200,000).

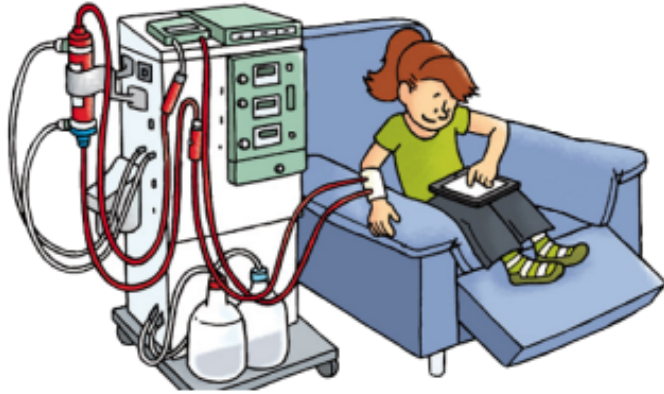
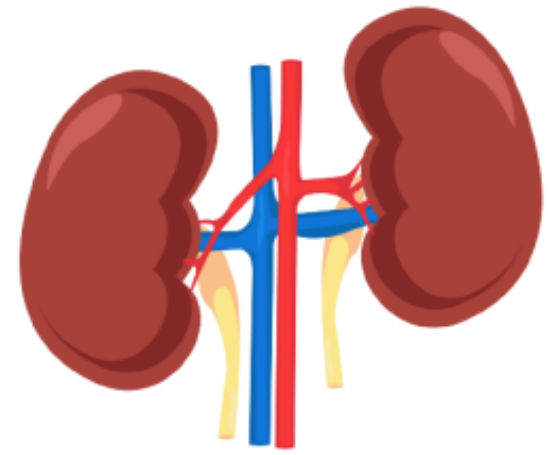

Dialysis

# Kidney Exchange

Many people suffer from kidney failure  
(waiting list in US: ~90,000; in India: ~200,000).

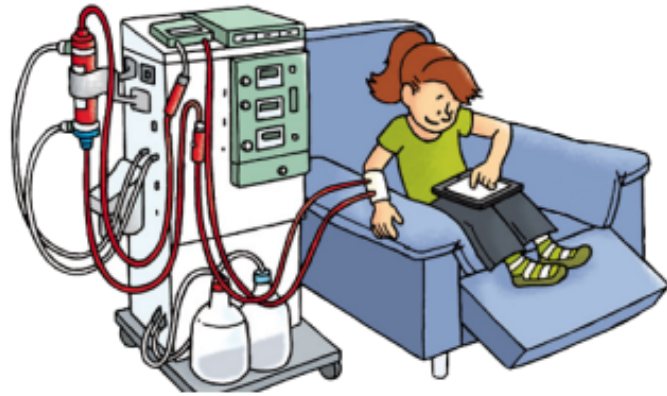
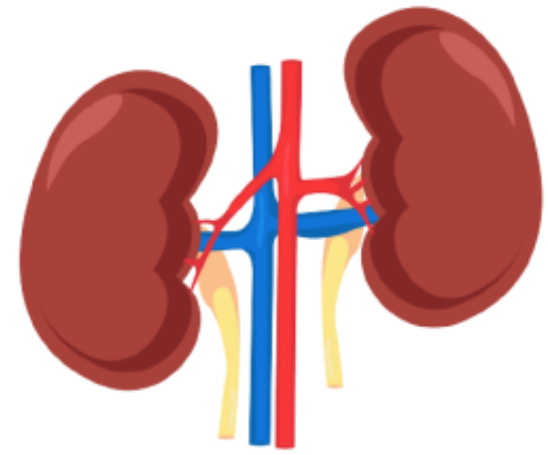

Dialysis

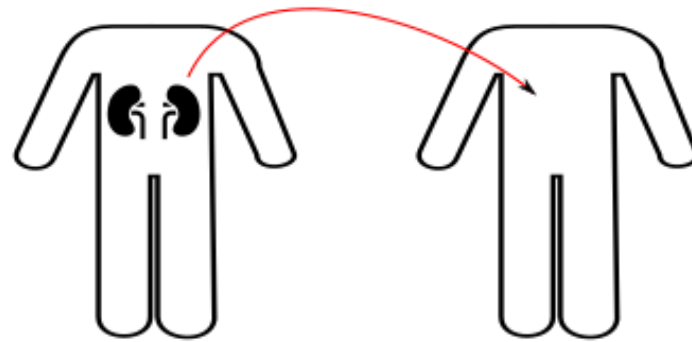

Transplant



# Kidney Exchange

Many people suffer from kidney failure  
(waiting list in US: ~90,000; in India: ~200,000).

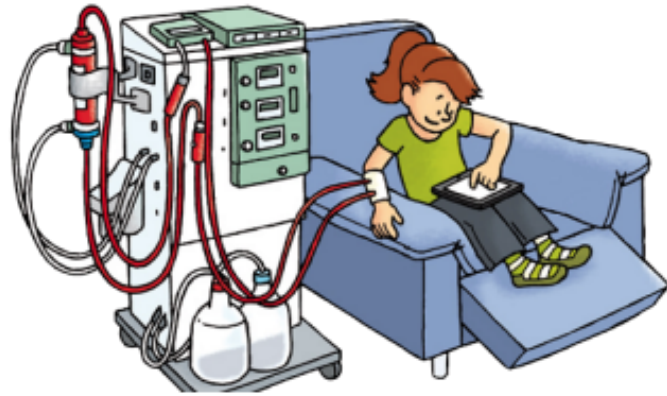
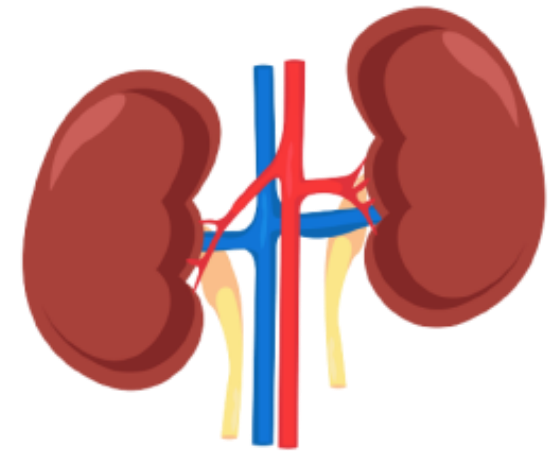

## Dialysis

Poor quality of life  
High cost

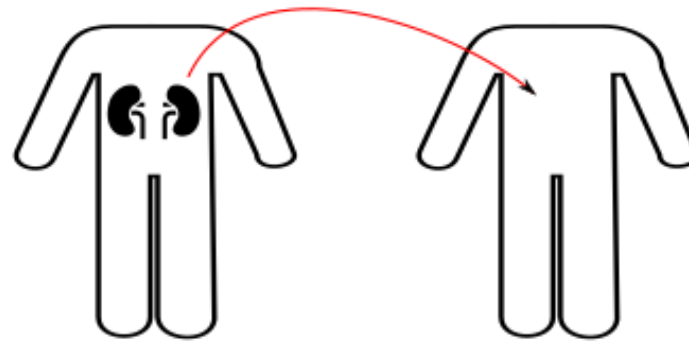

## Transplant

Better life quality  
Lower cost

# Kidney Exchange

Many people suffer from kidney failure  
(waiting list in US: ~90,000; in India: ~200,000).

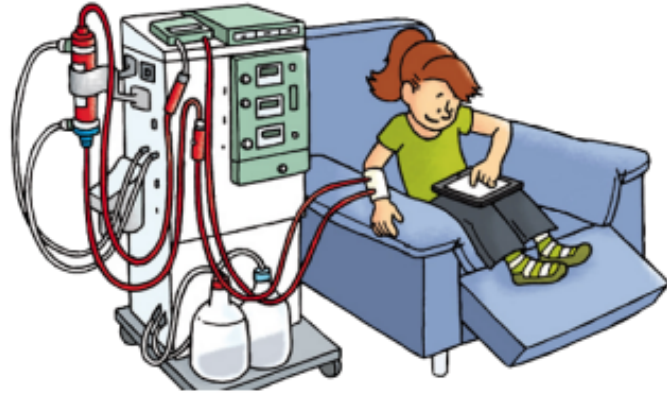
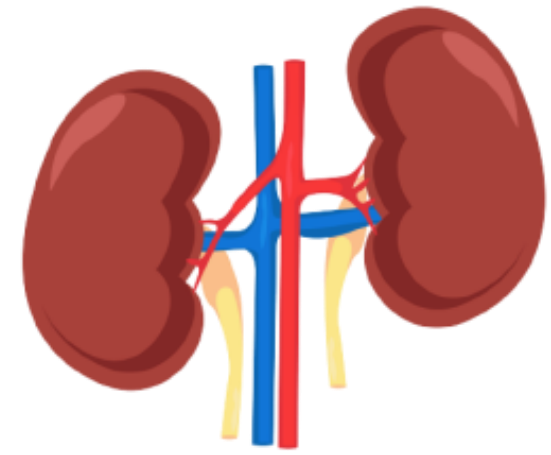

## Dialysis

Poor quality of life  
High cost

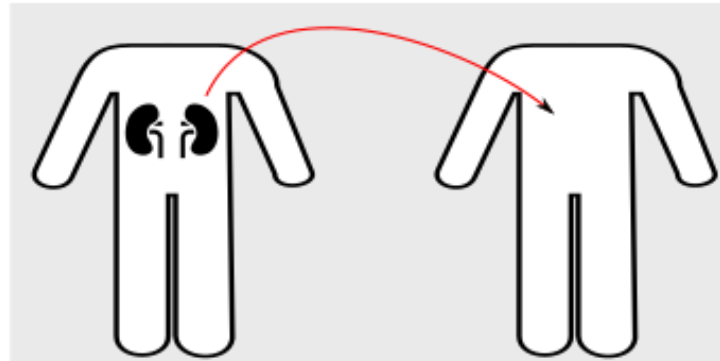

## Transplant

Better life quality  
Lower cost



# Kidney Exchange

Many people suffer from kidney failure  
(waiting list in US: ~90,000; in India: ~200,000).

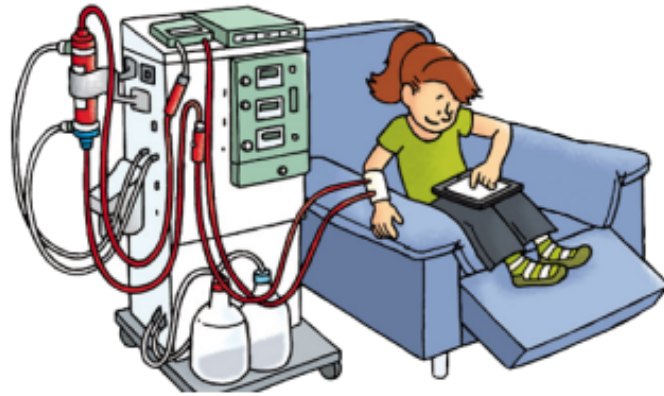
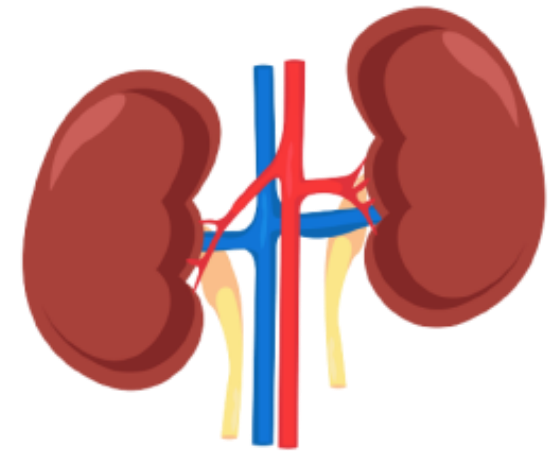

## Dialysis

Poor quality of life  
High cost

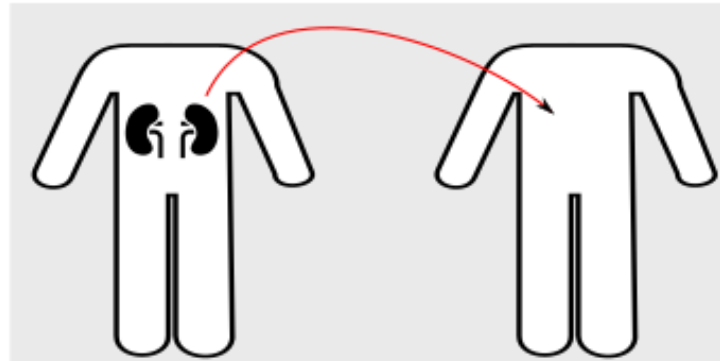

## Transplant

Better life quality  
Lower cost

- From a **deceased donor**

- From a **living donor**

# Kidney Exchange

Many people suffer from kidney failure  
(waiting list in US: ~90,000; in India: ~200,000).

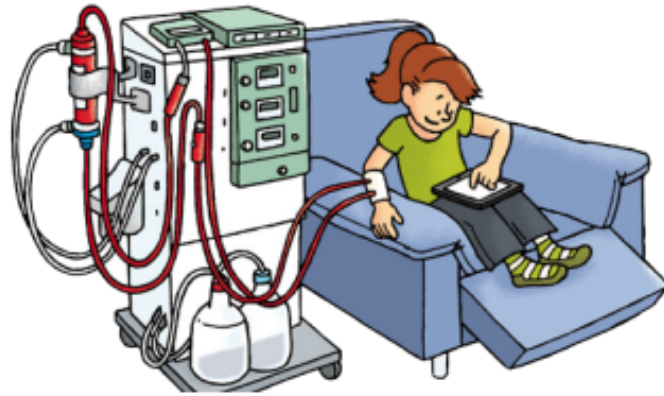
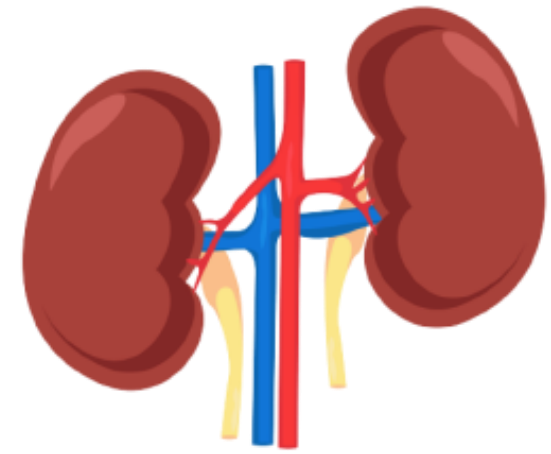

## Dialysis

Poor quality of life  
High cost

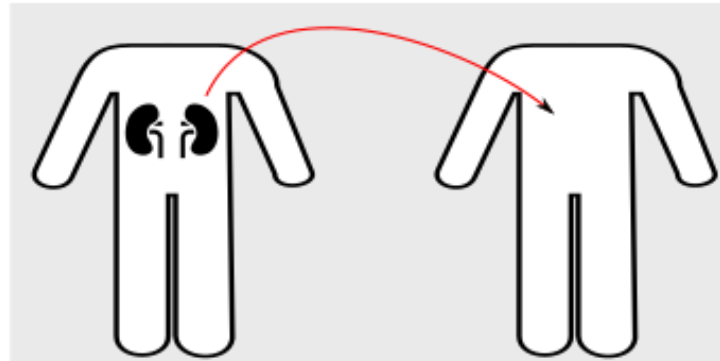

## Transplant

Better life quality  
Lower cost

- From a **deceased donor**



- From a **living donor**

# Kidney Exchange

Many people suffer from kidney failure  
(waiting list in US: ~90,000; in India: ~200,000).

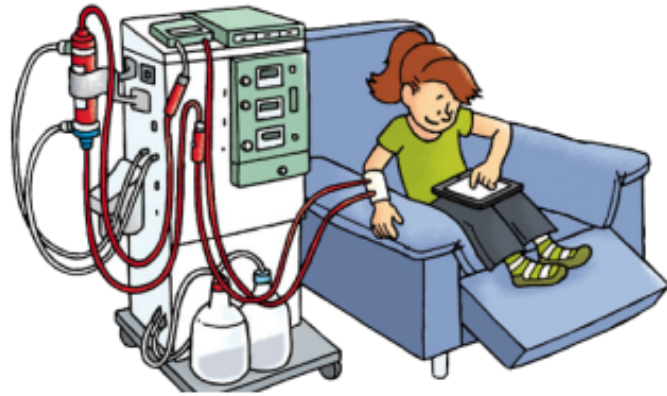
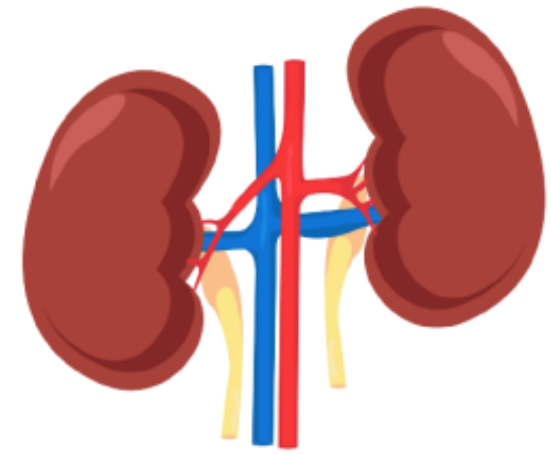

## Dialysis

Poor quality of life  
High cost

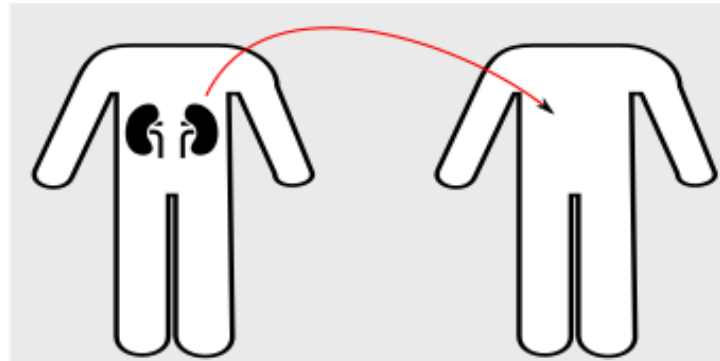

## Transplant

Better life quality  
Lower cost

- From a **deceased donor**



- From a **living donor**

E.g., first-degree relatives,  
spouse etc.

# Kidney Exchange

Simply having a willing donor is not enough.  
The organ must be **medically compatible**.

# Kidney Exchange

Simply having a willing donor is not enough.  
The organ must be **medically compatible**.

**Blood-type** incompatibility

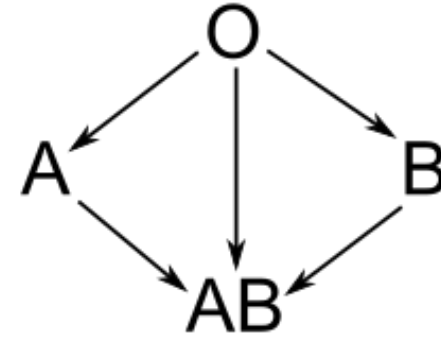

# Kidney Exchange

Simply having a willing donor is not enough.  
The organ must be **medically compatible**.

**Blood-type** incompatibility

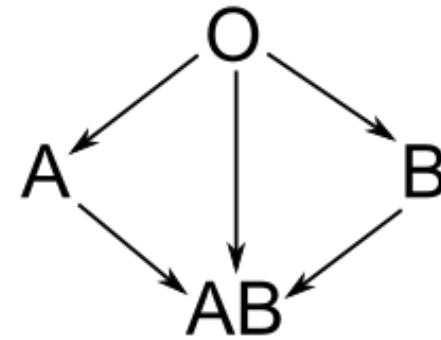
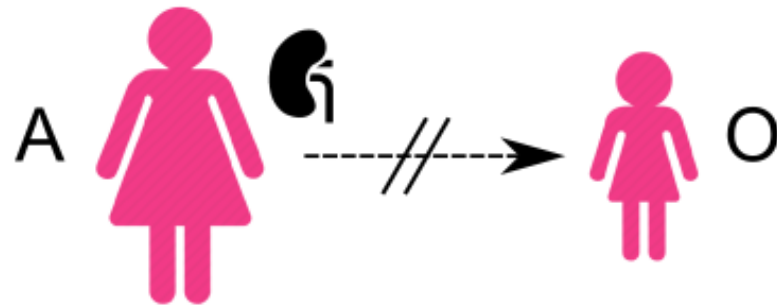

# Kidney Exchange

Simply having a willing donor is not enough.  
The organ must be **medically compatible**.

**Blood-type** incompatibility

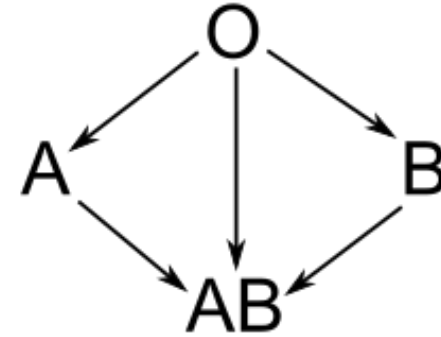
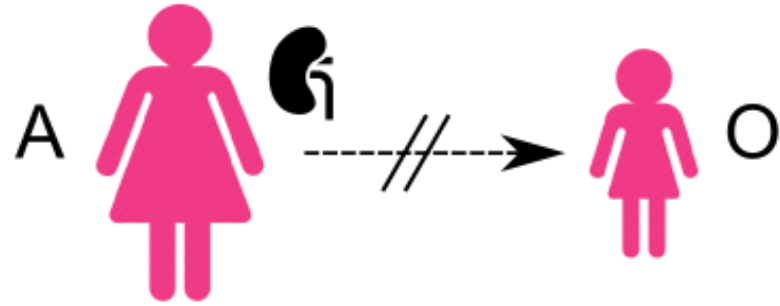

**Tissue-type** incompatibility

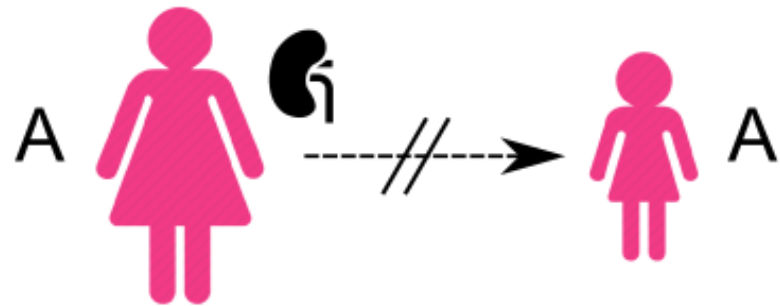

Sensitized patients with antibodies that will attack a foreign tissue (often due to prior exposure during blood transfusion, pregnancy, previous transplants).

# Kidney Exchange

[Rapaport, *Transpl. Proc.* 1986; Ross et al. *NEJM* 1997]



# Kidney Exchange

[Rapaport, *Transpl. Proc.* 1986; Ross et al. *NEJM* 1997]

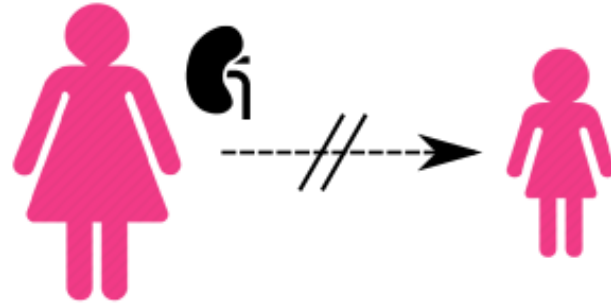

# Kidney Exchange

[Rapaport, *Transpl. Proc.* 1986; Ross et al. *NEJM* 1997]

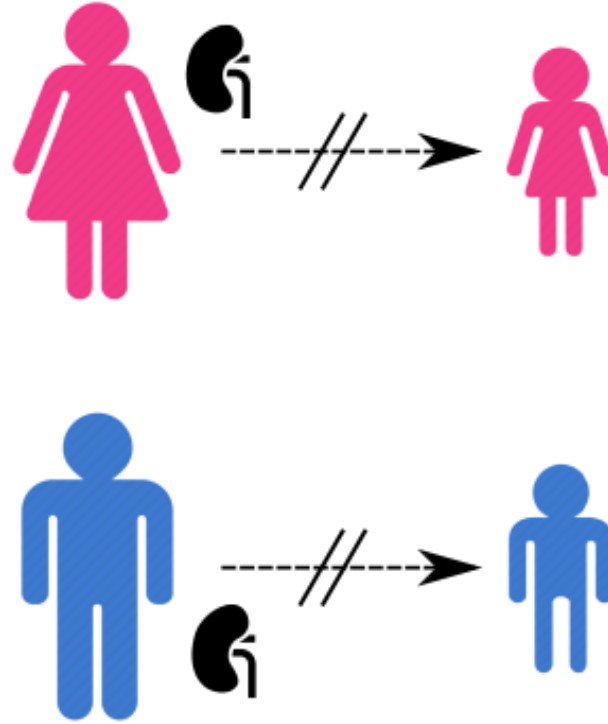

# Kidney Exchange

[Rapaport, *Transpl. Proc.* 1986; Ross et al. *NEJM* 1997]

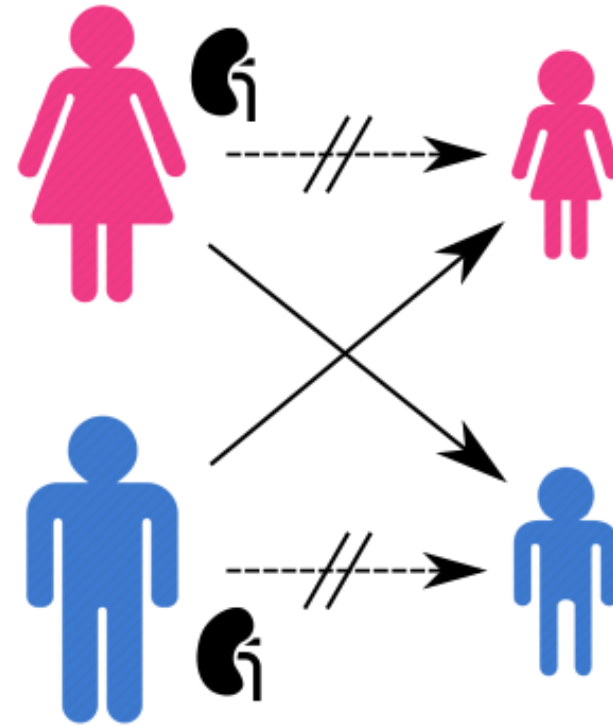

# Kidney Exchange

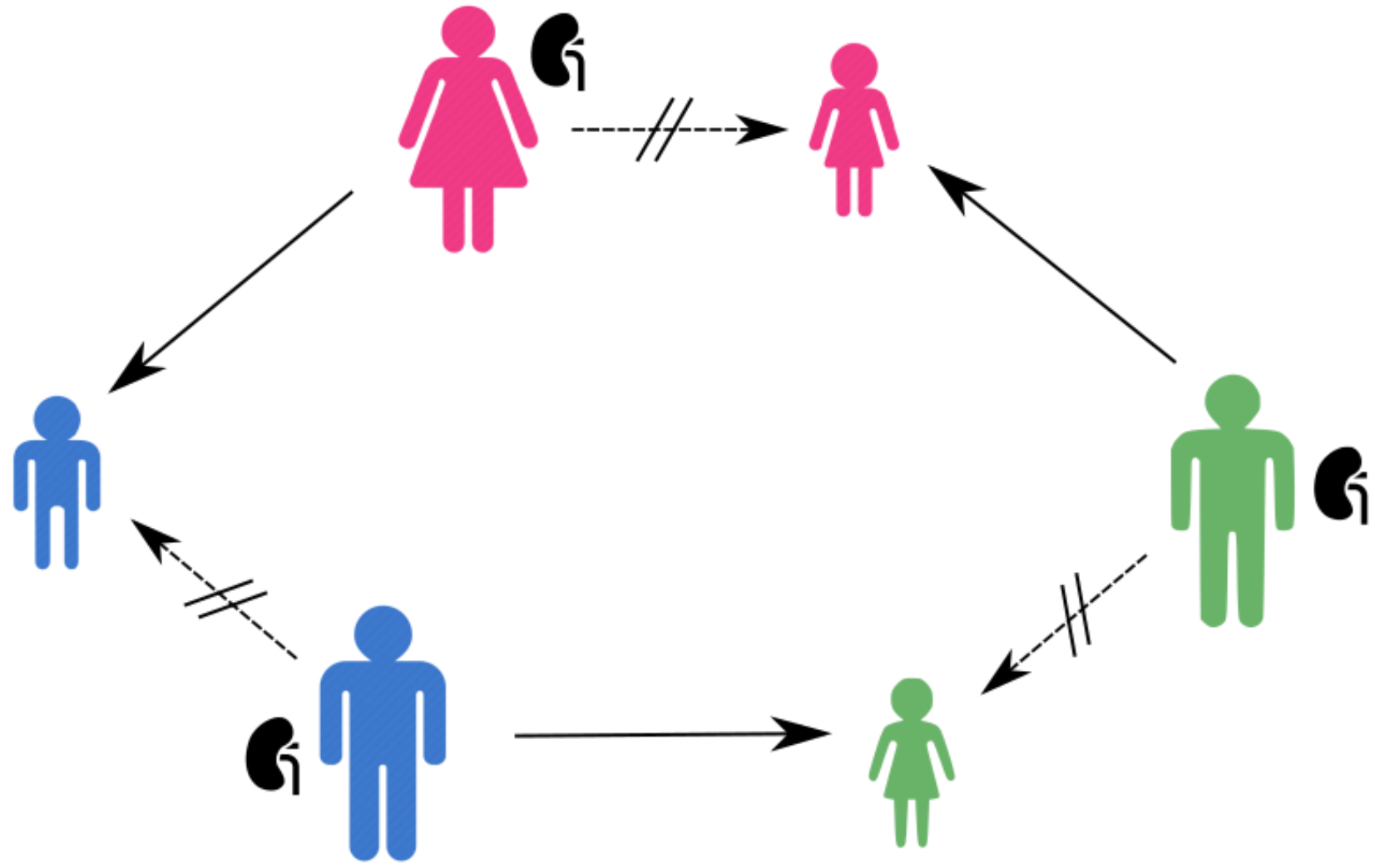

# Kidney Exchange

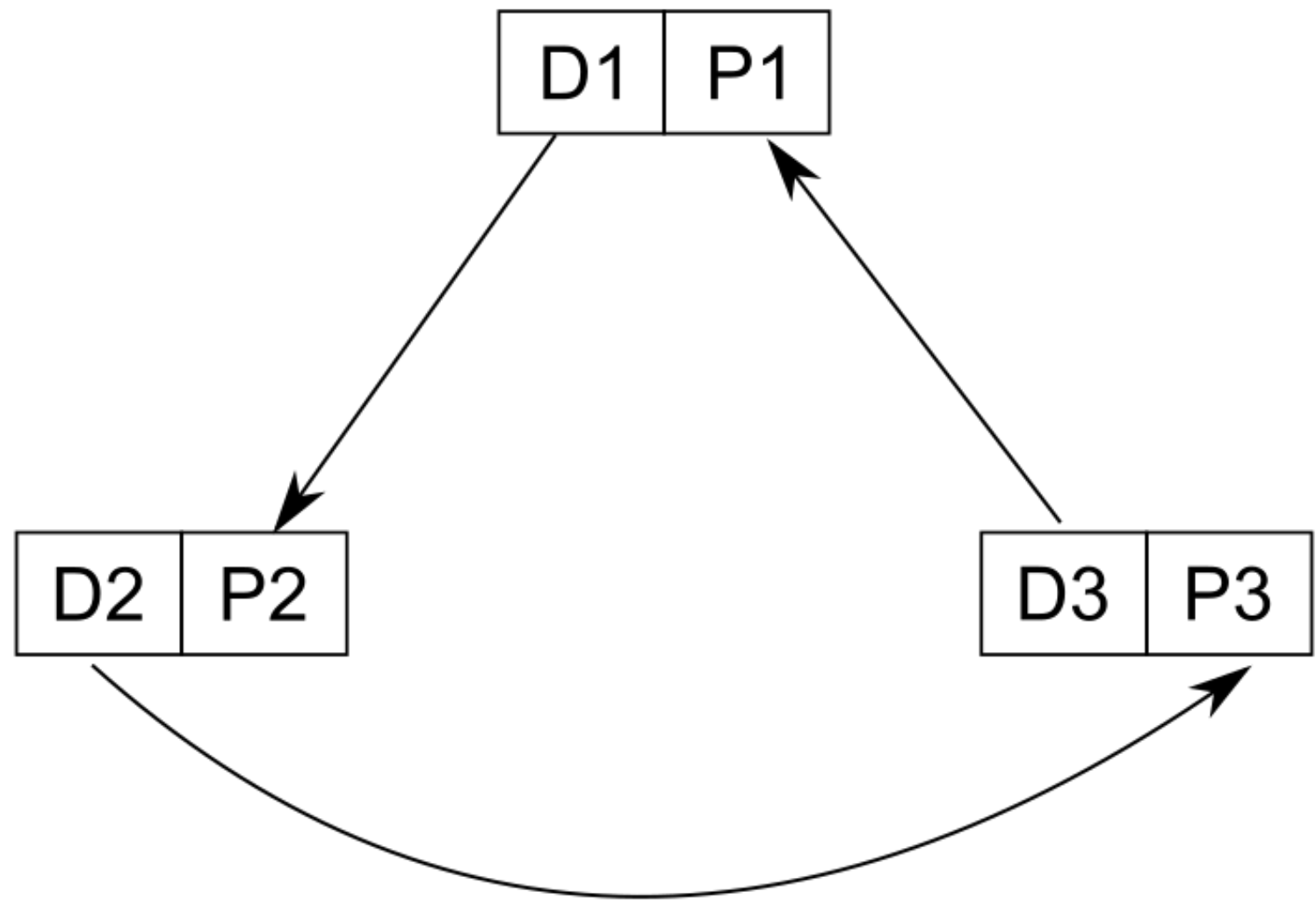

# Kidney Exchange

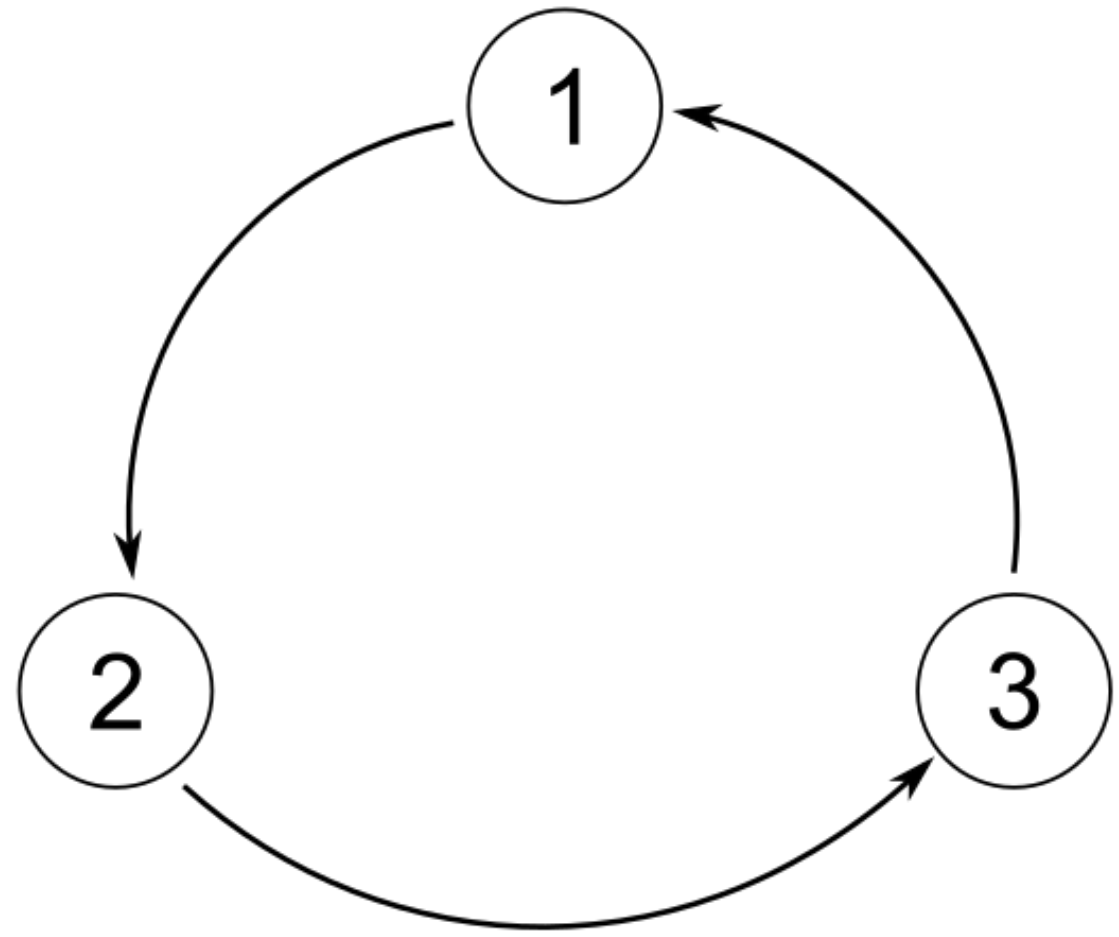
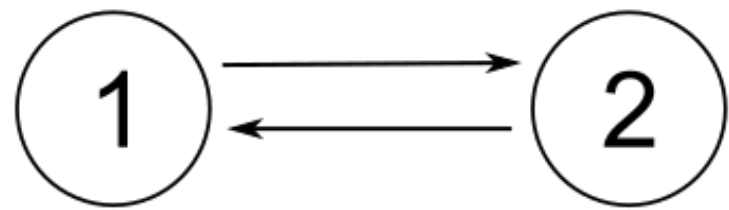

# Kidney Exchange

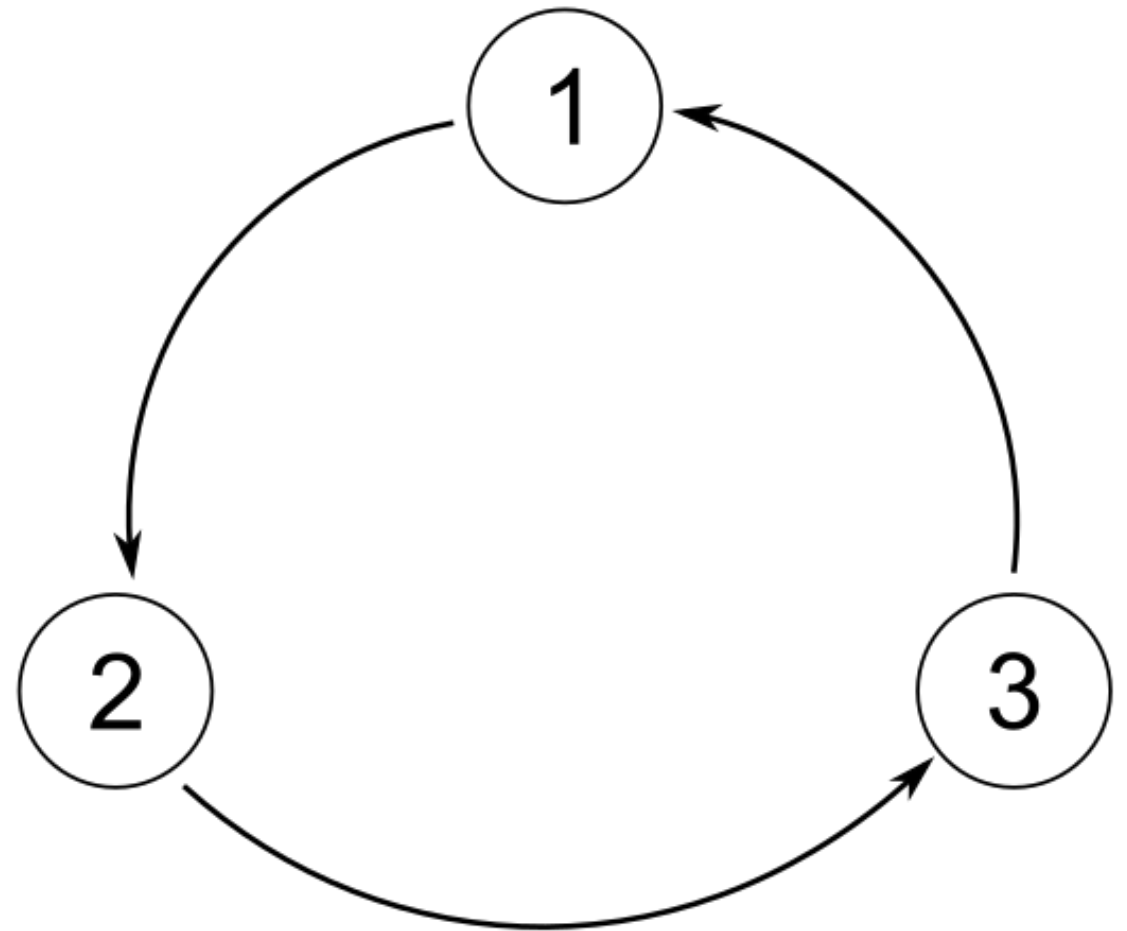
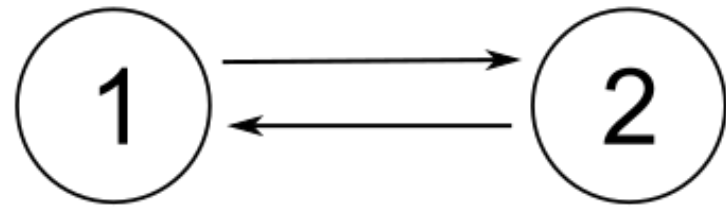

Intuitively, having more and more of such willing-but-incompatible pairs will create more opportunities for an exchange.

## History [\[ edit \]](#)

Year	Event
1986	KPD first suggested by Rapaport <sup>[14]</sup>
1991	First KPD program started in South Korea by Dr. Park <sup>[8]</sup>
1999	First European KPD transplants performed in Switzerland <sup>[8]</sup>
2000	First KPD transplants performed in USA at the Rhode Island Hospital <sup>[8]</sup>
2001	Hopkins completes KPD transplants and begins first KPD program in USA <sup>[15]</sup>
2004	Dutch established first national KPD program <sup>[8]</sup>
2007	NEAD chain started by APD utilizing first bridge donor <sup>[16]</sup>
2007	Charlie Norwood Living Organ Donation Act clarifies legality of KPD in USA <sup>[17]</sup>
2008	National Kidney Registry organizes its first transplants on Valentine's Day <sup>[18]</sup>
2009	Hopkins leads first 16 patient multicenter Domino Chain <sup>[19][20]</sup>
2010	UNOS organizes its first KPD transplants <sup>[8]</sup>
2012	National Kidney Registry completes largest chain involving 60 participants <sup>[6]</sup>
2014	National Kidney Registry sets new record with 70 participant chain <sup>[7]</sup>
2017	First Academic Paper published on "Chronological Incompatibility" outlining the ADP Voucher Program" <sup>[21]</sup>



# History [\[ edit \]](#)

Year	Event
1986	KPD first suggested by Rapaport <sup>[14]</sup>
1991	First KPD program started in South Korea by Dr. Park <sup>[8]</sup>
1999	First European KPD transplants performed in Switzerland <sup>[8]</sup>
2000	First KPD transplants performed in USA at the Rhode Island Hospital <sup>[8]</sup>
2001	Hopkins completes KPD transplants and begins first KPD program in USA <sup>[15]</sup>
2004	Dutch established first national KPD program <sup>[8]</sup>
2007	NEAD chain started by APD utilizing first bridge donor <sup>[16]</sup>
2007	Charlie Norwood Living Organ Donation Act clarifies legality of KPD in USA <sup>[17]</sup>
2008	National Kidney Registry organizes its first transplants on Valentine's Day <sup>[18]</sup>
2009	Hopkins leads first 16 patient multicenter Domino Chain <sup>[19][20]</sup>
2010	UNOS organizes its first KPD transplants <sup>[8]</sup>
2012	National Kidney Registry completes largest chain involving 60 participants <sup>[6]</sup>
2014	National Kidney Registry sets new record with 70 participant chain <sup>[7]</sup>
2017	First Academic Paper published on "Chronological Incompatibility" outlining the ADP Voucher Program" <sup>[21]</sup>

# Early Proposals for Kidney Exchange

# Early Proposals for Kidney Exchange

Proposal 1

Using TTCA



Proposal 2



# Proposal 1: Kidney Exchange using TTCA

[Roth, Sönmez, and Ünver, *QJE* 2004]

# Proposal 1: Kidney Exchange using TTCA

[Roth, Sönmez, and Ünver, *QJE* 2004]

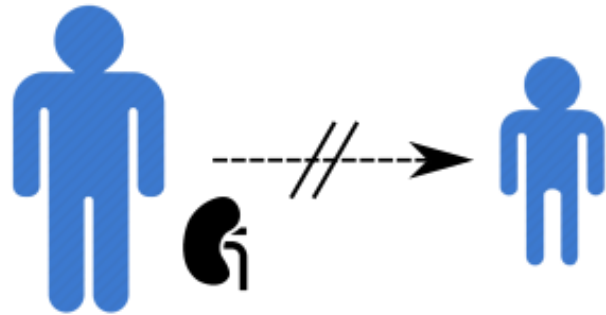
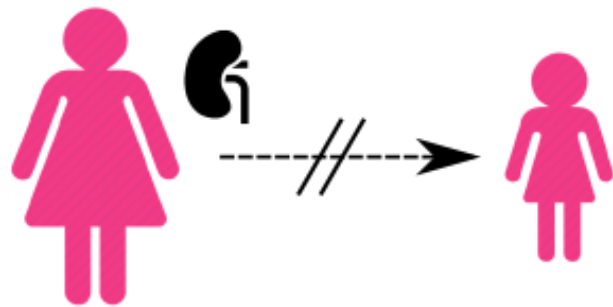

# Proposal 1: Kidney Exchange using TTCA

[Roth, Sönmez, and Ünver, *QJE* 2004]

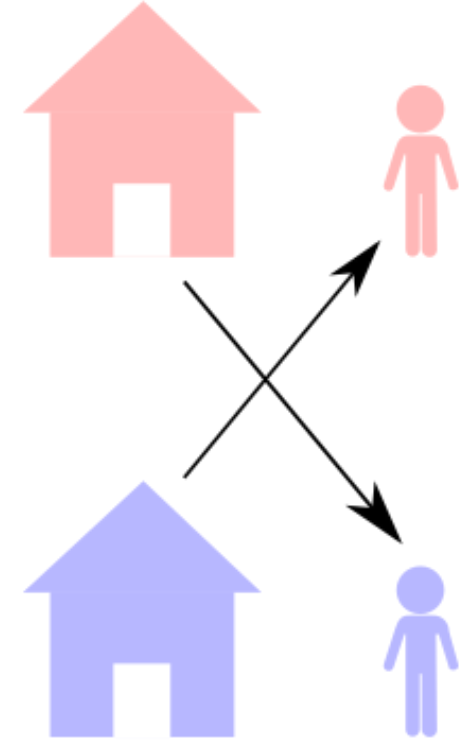
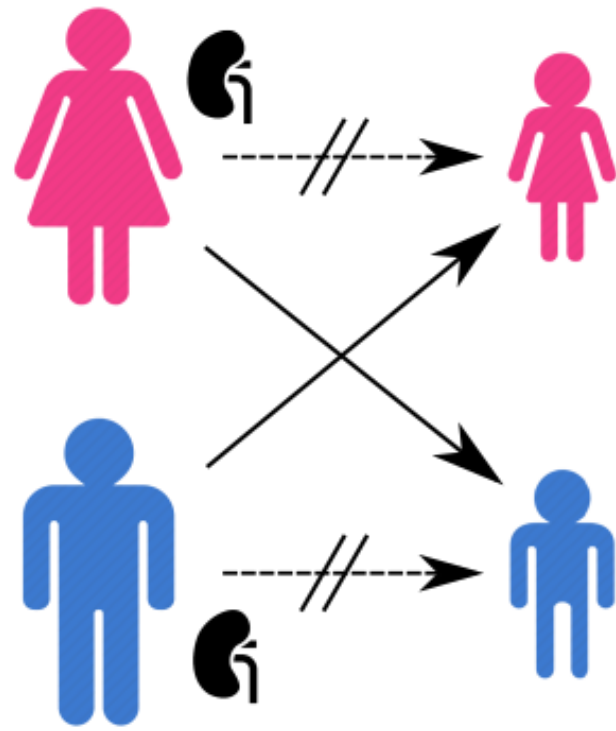

# Proposal 1: Kidney Exchange using TTCA

[Roth, Sönmez, and Ünver, *QJE* 2004]

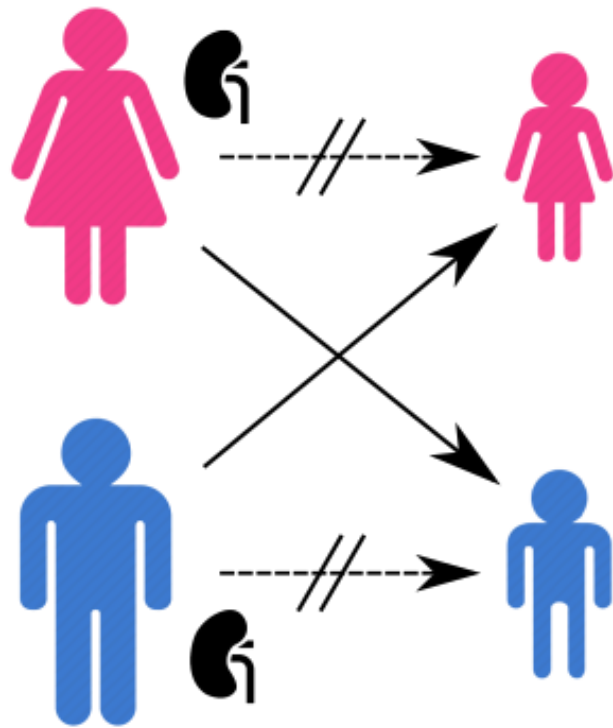

Each patient has a strict ranking of donors.

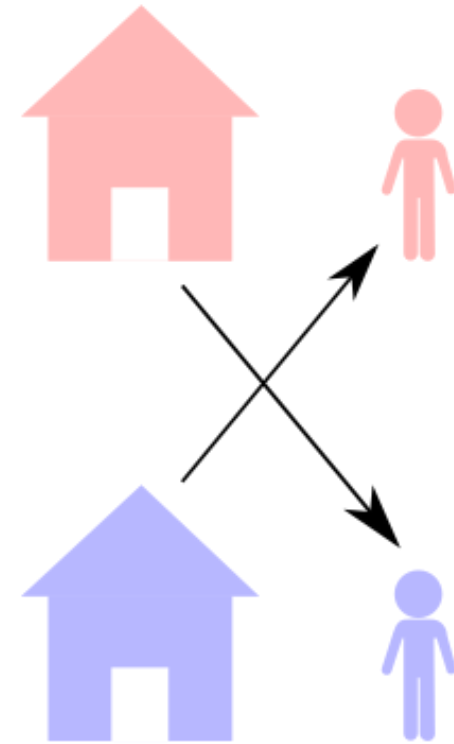

Each agent has a strict ranking of houses.

# Proposal 1: Kidney Exchange using TTCA

[Roth, Sönmez, and Ünver, *QJE* 2004]

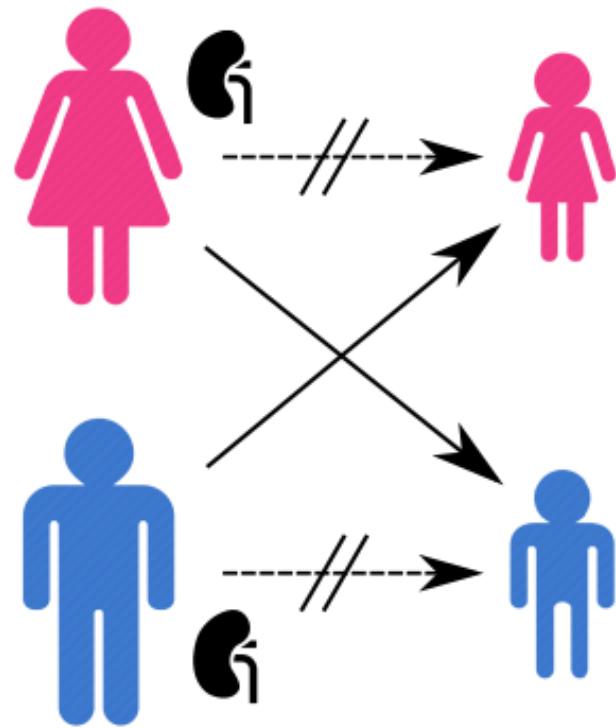

Each patient has a  
strict ranking of donors.  
(medically determined)

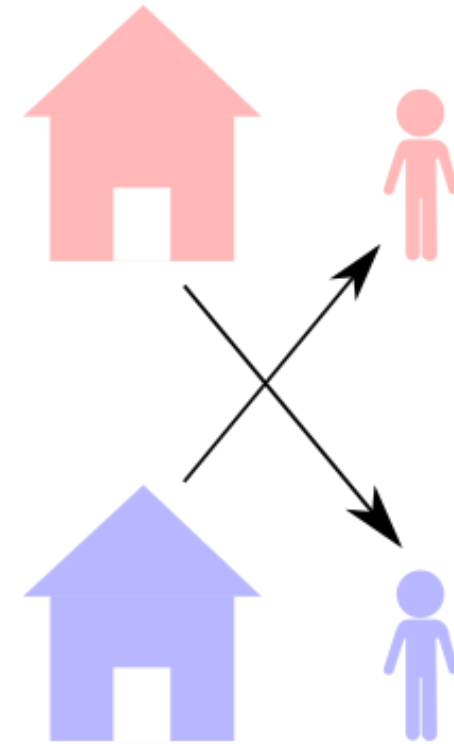

Each agent has a  
strict ranking of houses.  
(idiosyncratic)



# Advantages of Kidney Exchange using TTCA

# Advantages of Kidney Exchange using TTCA



No group of patients can strictly improve by reallocating donors among themselves.

# Advantages of Kidney Exchange using TTCA



No group of patients can strictly improve by reallocating donors among themselves.



Every patient is (weakly) better off than before.

# Advantages of Kidney Exchange using TTCA



No group of patients can strictly improve by reallocating donors among themselves.



Every patient is (weakly) better off than before.



Polynomial time.

# Limitations of Kidney Exchange using TTCA

# Limitations of Kidney Exchange using TTCA

In practice, there may be:



- patients without a donor ("agents without a house")
- deceased donors ("house without an owner").

# Limitations of Kidney Exchange using TTCA

In practice, there may be:



- patients without a donor ("agents without a house")
- deceased donors ("house without an owner").

"You request my house---I get your turn" [Abdulkadiroğlu and Sönmez, JET 1999]

# Limitations of Kidney Exchange using TTCA

In practice, there may be:



- patients without a donor ("agents without a house")
- deceased donors ("house without an owner").

"You request my house---I get your turn" [Abdulkadiroğlu and Sönmez, JET 1999]





# Limitations of Kidney Exchange using TTCA

In practice, there may be:



- patients without a donor ("agents without a house")
- deceased donors ("house without an owner").

"You request my house---I get your turn" [Abdulkadiroğlu and Sönmez, JET 1999]



# Limitations of Kidney Exchange using TTCA

In practice, there may be:



- patients without a donor ("agents without a house")
- deceased donors ("house without an owner").

"You request my house---I get your turn" [Abdulkadiroğlu and Sönmez, JET 1999]



3

4



2



1

5



# Limitations of Kidney Exchange using TTCA

In practice, there may be:



- patients without a donor ("agents without a house")
- deceased donors ("house without an owner").

"You request my house---I get your turn" [Abdulkadiroğlu and Sönmez, JET 1999]



# Limitations of Kidney Exchange using TTCA

In practice, there may be:



- patients without a donor ("agents without a house")
- deceased donors ("house without an owner").

"You request my house---I get your turn" [Abdulkadiroğlu and Sönmez, JET 1999]

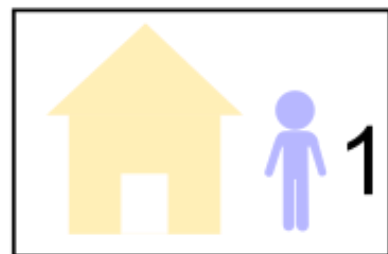

# Limitations of Kidney Exchange using TTCA

In practice, there may be:



- patients without a donor ("agents without a house")
- deceased donors ("house without an owner").

"You request my house---I get your turn" [Abdulkadiroğlu and Sönmez, JET 1999]



# Limitations of Kidney Exchange using TTCA

In practice, there may be:



- patients without a donor ("agents without a house")
- deceased donors ("house without an owner").

"You request my house---I get your turn" [Abdulkadiroğlu and Sönmez, JET 1999]

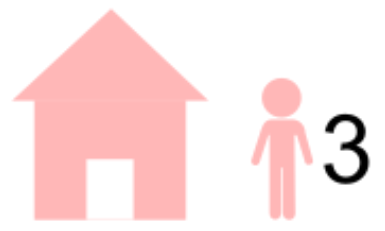

# Limitations of Kidney Exchange using TTCA

In practice, there may be:



- patients without a donor ("agents without a house")
- deceased donors ("house without an owner").

"You request my house---I get your turn" [Abdulkadiroğlu and Sönmez, JET 1999]



# Limitations of Kidney Exchange using TTCA

In practice, there may be:



- patients without a donor ("agents without a house")
- deceased donors ("house without an owner").

"You request my house---I get your turn" [Abdulkadiroğlu and Sönmez, JET 1999]





# Limitations of Kidney Exchange using TTCA

In practice, there may be:



- patients without a donor ("agents without a house")
- deceased donors ("house without an owner").

"You request my house---I get your turn" [Abdulkadiroğlu and Sönmez, JET 1999]



# Limitations of Kidney Exchange using TTCA

In practice, there may be:



- patients without a donor ("agents without a house")
- deceased donors ("house without an owner").

"You request my house---I get your turn" [Abdulkadiroğlu and Sönmez, JET 1999]



# Limitations of Kidney Exchange using TTCA

In practice, there may be:



- patients without a donor ("agents without a house")
- deceased donors ("house without an owner").

"You request my house---I get your turn" [Abdulkadiroğlu and Sönmez, JET 1999]



# Limitations of Kidney Exchange using TTCA

In practice, there may be:



- patients without a donor ("agents without a house")
- deceased donors ("house without an owner").

"You request my house---I get your turn" [Abdulkadiroğlu and Sönmez, JET 1999]

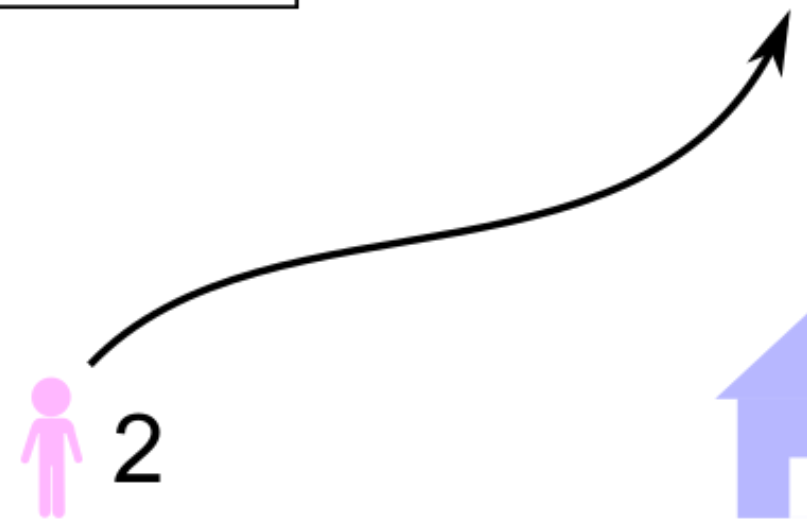

# Limitations of Kidney Exchange using TTCA

In practice, there may be:



- patients without a donor ("agents without a house")
- deceased donors ("house without an owner").

"You request my house---I get your turn" [Abdulkadiroğlu and Sönmez, JET 1999]

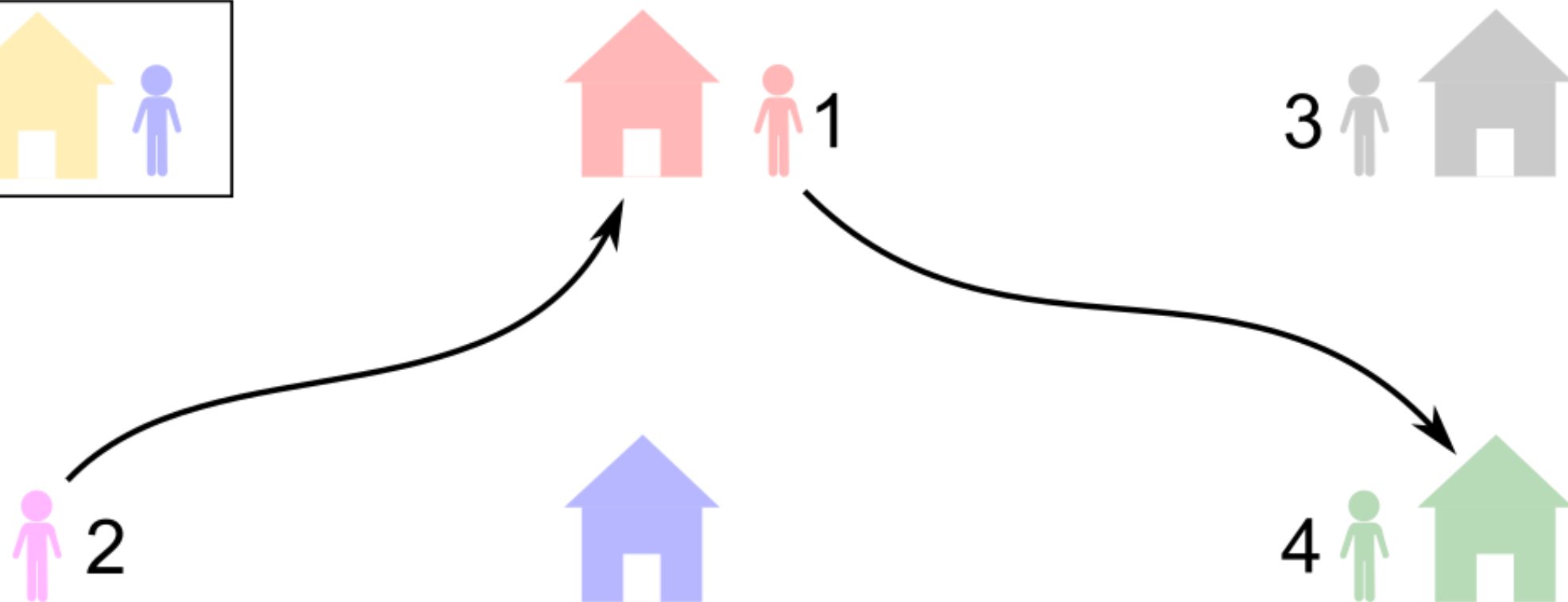

# Limitations of Kidney Exchange using TTCA

In practice, there may be:



- patients without a donor ("agents without a house")
- deceased donors ("house without an owner").

"You request my house---I get your turn" [Abdulkadiroğlu and Sönmez, JET 1999]

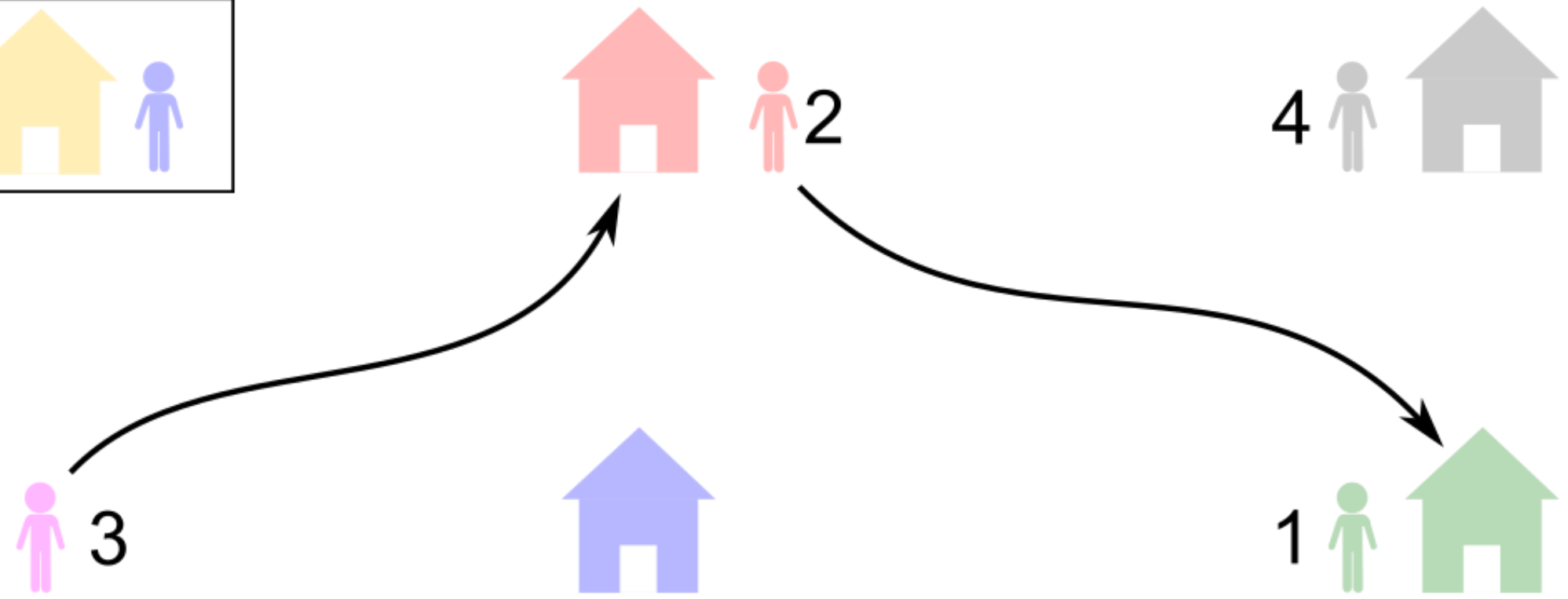

# Limitations of Kidney Exchange using TTCA

In practice, there may be:



- patients without a donor ("agents without a house")
- deceased donors ("house without an owner").

"You request my house---I get your turn" [Abdulkadiroğlu and Sönmez, JET 1999]

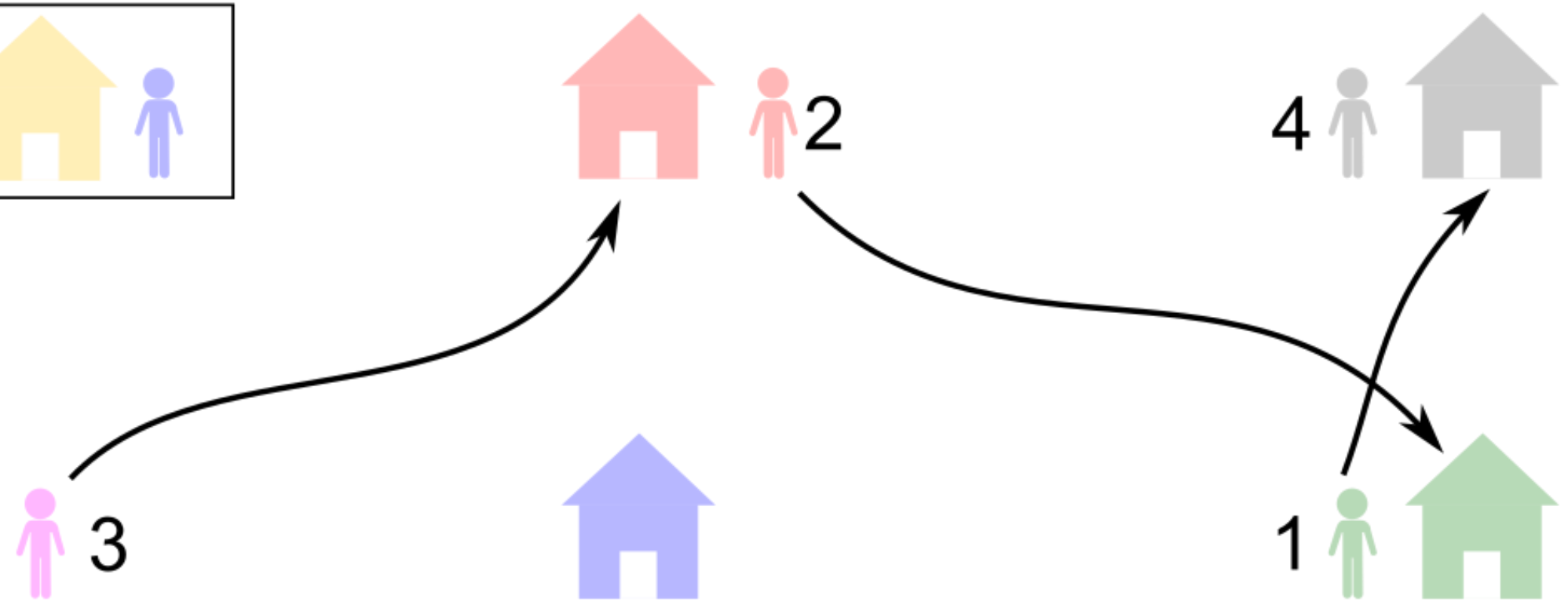

# Limitations of Kidney Exchange using TTCA

In practice, there may be:



- patients without a donor ("agents without a house")
- deceased donors ("house without an owner").

"You request my house---I get your turn" [Abdulkadiroğlu and Sönmez, JET 1999]

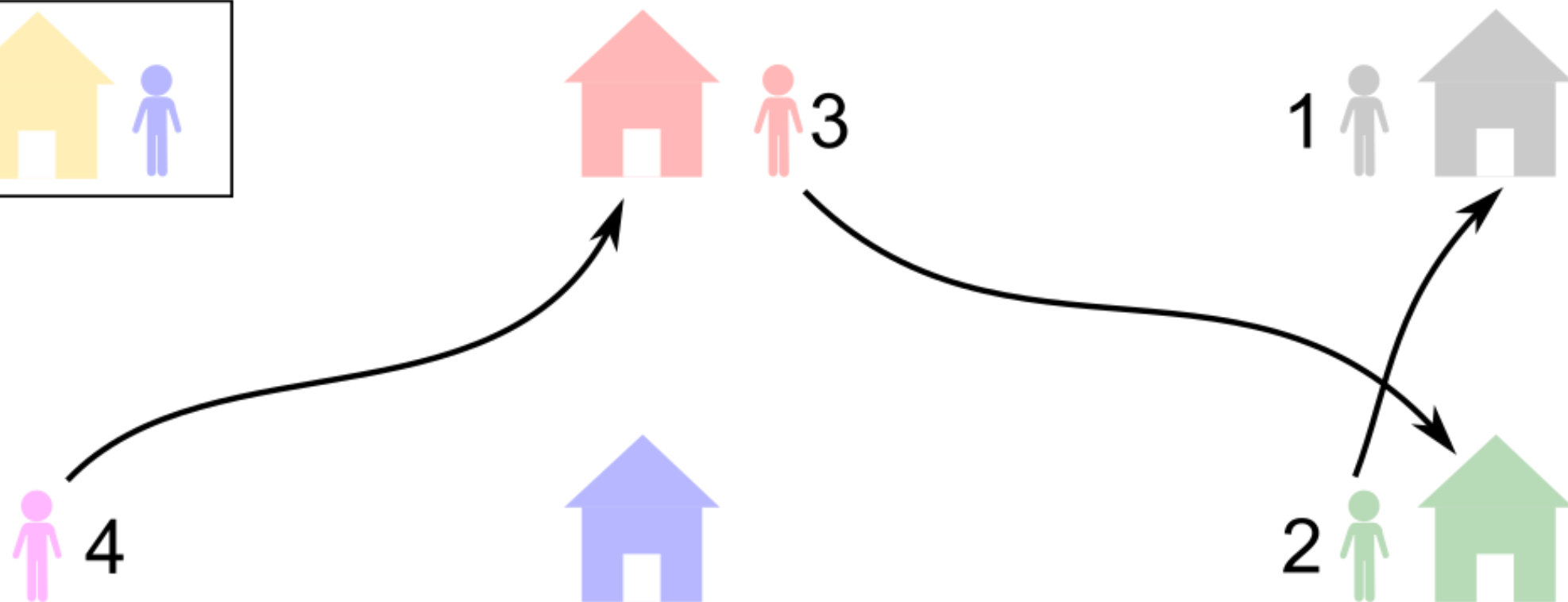



# Limitations of Kidney Exchange using TTCA

In practice, there may be:



- patients without a donor ("agents without a house")
- deceased donors ("house without an owner").

"You request my house---I get your turn" [Abdulkadiroğlu and Sönmez, JET 1999]

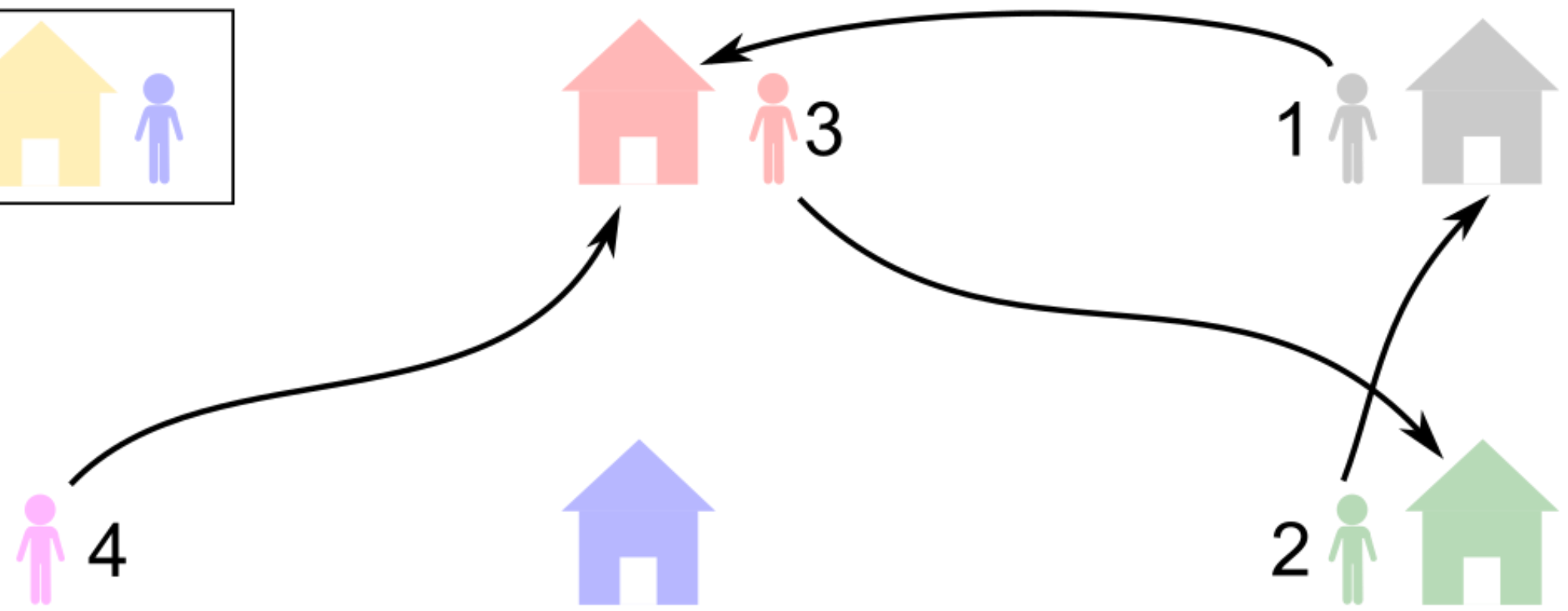

# Limitations of Kidney Exchange using TTCA

In practice, there may be:



- patients without a donor ("agents without a house")
- deceased donors ("house without an owner").

"You request my house---I get your turn" [Abdulkadiroğlu and Sönmez, JET 1999]

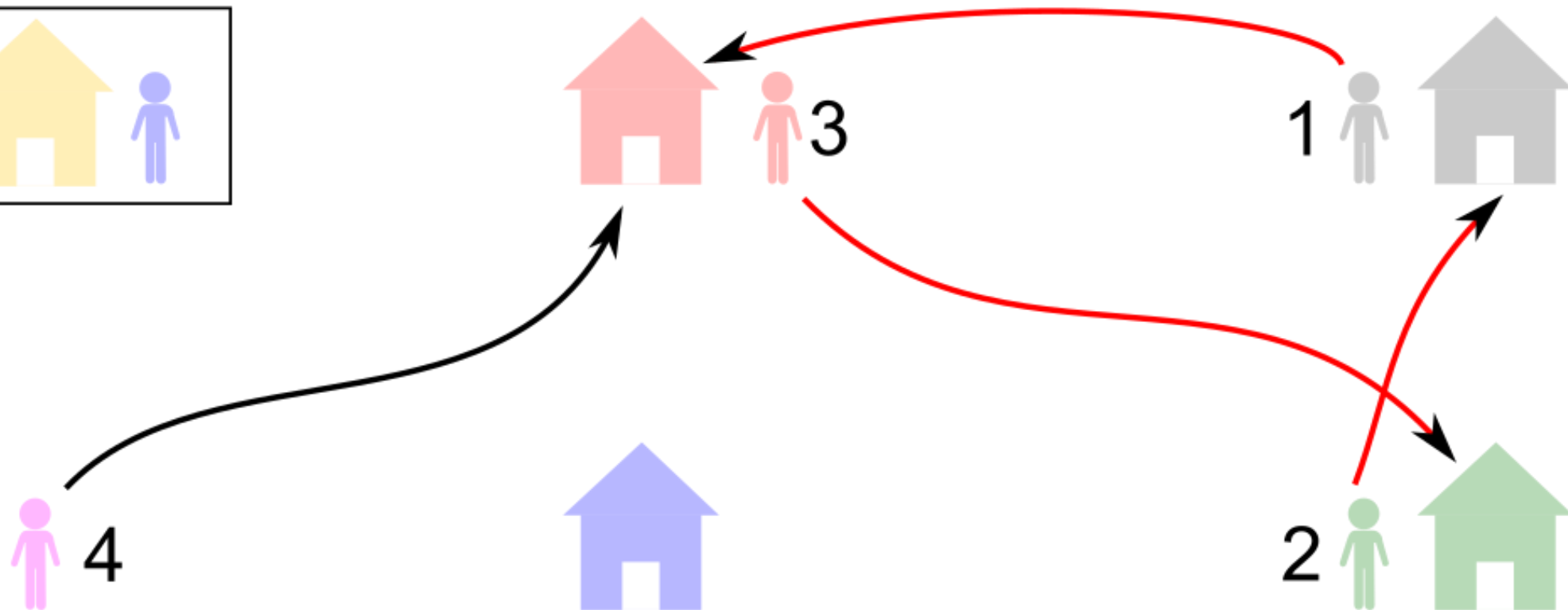

# Limitations of Kidney Exchange using TTCA

In practice, there may be:



- patients without a donor ("agents without a house")
- deceased donors ("house without an owner").

"You request my house---I get your turn" [Abdulkadiroğlu and Sönmez, JET 1999]

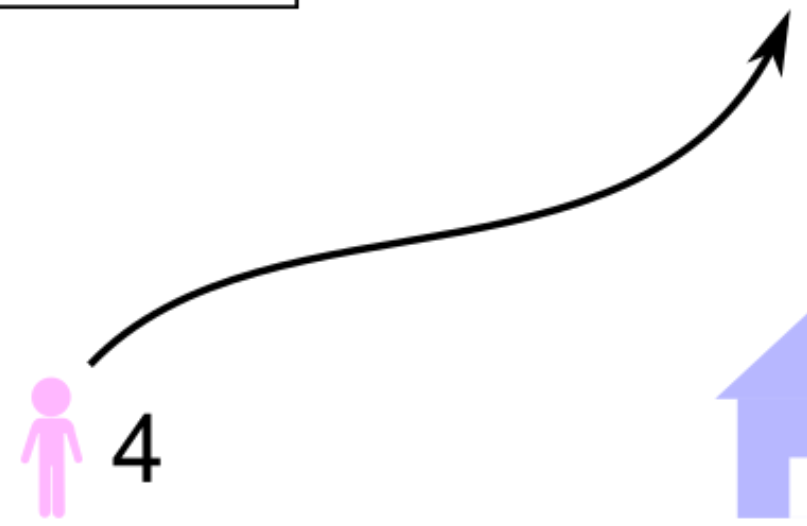
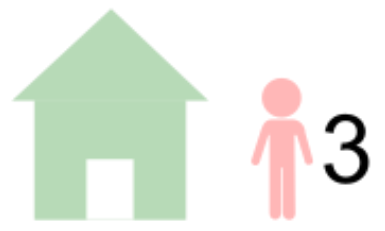

# Limitations of Kidney Exchange using TTCA

In practice, there may be:



- patients without a donor ("agents without a house")
- deceased donors ("house without an owner").

"You request my house---I get your turn" [Abdulkadiroğlu and Sönmez, JET 1999]



# Limitations of Kidney Exchange using TTCA

In practice, there may be:



- patients without a donor ("agents without a house")
- deceased donors ("house without an owner").

"You request my house---I get your turn" [Abdulkadiroğlu and Sönmez, JET 1999]



# Limitations of Kidney Exchange using TTCA

In practice, there may be:



- patients without a donor ("agents without a house")
- deceased donors ("house without an owner").

"You request my house---I get your turn" [Abdulkadiroğlu and Sönmez, JET 1999]



# Limitations of Kidney Exchange using TTCA

In practice, there may be:



- patients without a donor ("agents without a house")
- deceased donors ("house without an owner").

"You request my house---I get your turn" [Abdulkadiroğlu and Sönmez, JET 1999]



# Limitations of Kidney Exchange using TTCA

In practice, there may be:



- patients without a donor ("agents without a house")
- deceased donors ("house without an owner").

"You request my house---I get your turn" [Abdulkadiroğlu and Sönmez, JET 1999]



# Limitations of Kidney Exchange using TTCA



In practice, there may be:

- patients without a donor ("agents without a house")
- deceased donors ("house without an owner").

"You request my house---I get your turn" [Abdulkadiroğlu and Sönmez, JET 1999]

**A key difference:**

In housing market, the set of "house without owners" is assumed to be **fixed**.  
In kidney exchange, deceased donor organs tend to arrive **sequentially**.

# Limitations of Kidney Exchange using TTCA

In practice, there may be:



- patients without a donor ("agents without a house")
- deceased donors ("house without an owner").

"You request my house---I get your turn" [Abdulkadiroğlu and Sönmez, JET 1999]

**A key difference:**

In housing market, the set of "house without owners" is assumed to be **fixed**.  
In kidney exchange, deceased donor organs tend to arrive **sequentially**.

So, patients are given the option to join the **waiting list** for deceased donor organs in anticipation of a better match.

# Limitations of Kidney Exchange using TTCA



In practice, there may be:

- patients without a donor ("agents without a house")
- deceased donors ("house without an owner").

"You request my house--I get your turn" [Abdulkadiroğlu and Sönmez, JET 1999]

**A key difference:**

In housing market, the set of "house without owners" is assumed to be **fixed**.  
In kidney exchange, deceased donor organs tend to arrive **sequentially**.

So, patients are given the option to join the **waiting list** for deceased donor organs in anticipation of a better match.

An algorithm called "**Top trading cycles and chains**" can handle this aspect [Roth, Sönmez, and Ünver, QJE 2004].

# Limitations of Kidney Exchange using TTCA

# Limitations of Kidney Exchange using TTCA



Long cycles can lead to **logistical problems**.

# Limitations of Kidney Exchange using TTCA



Long cycles can lead to **logistical problems**.

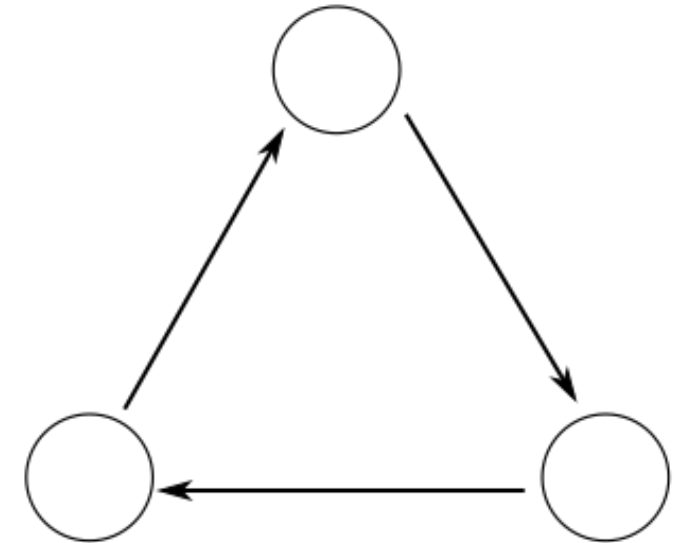
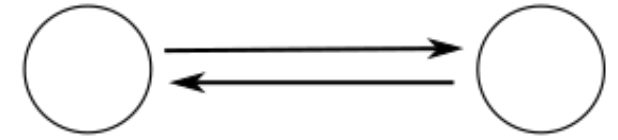
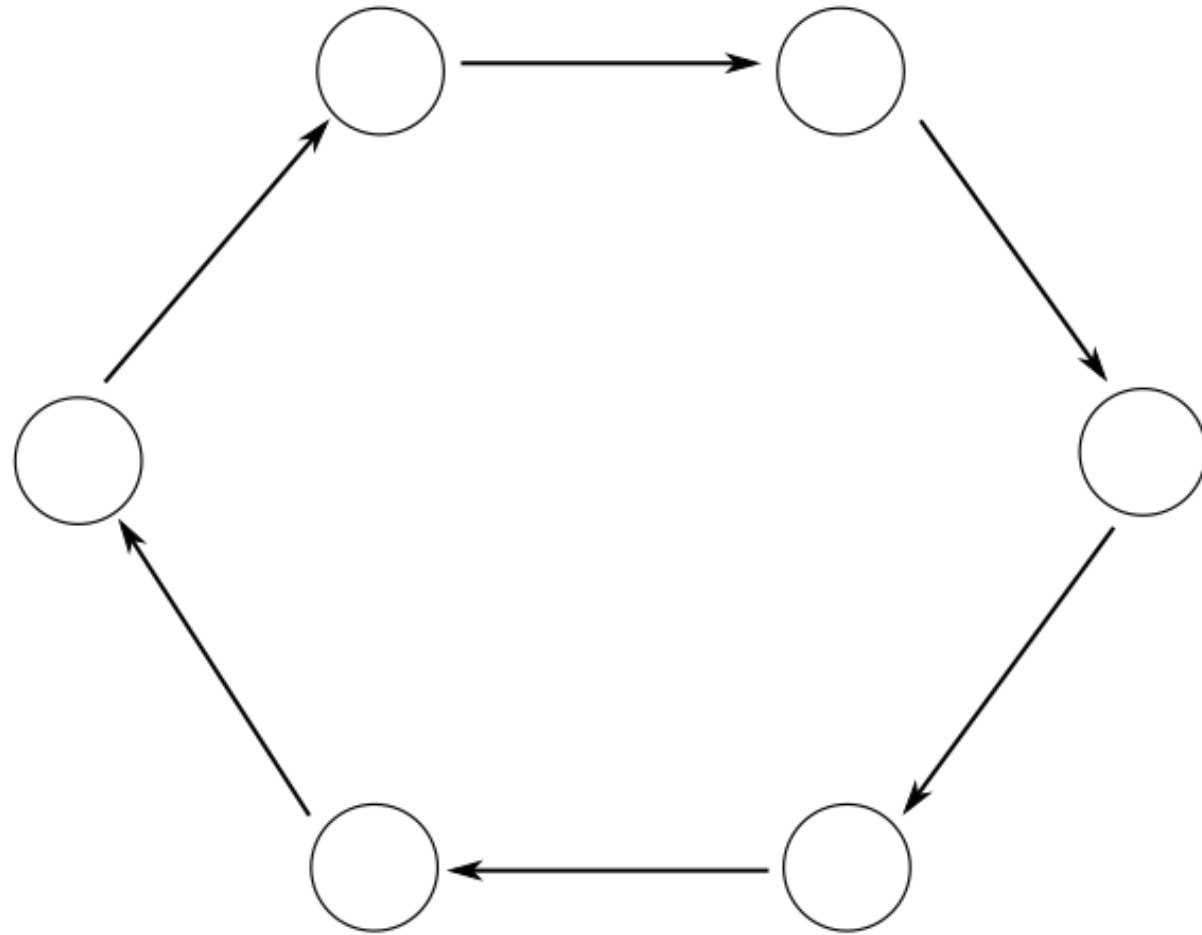

# Limitations of Kidney Exchange using TTCA



Long cycles can lead to **logistical problems**.

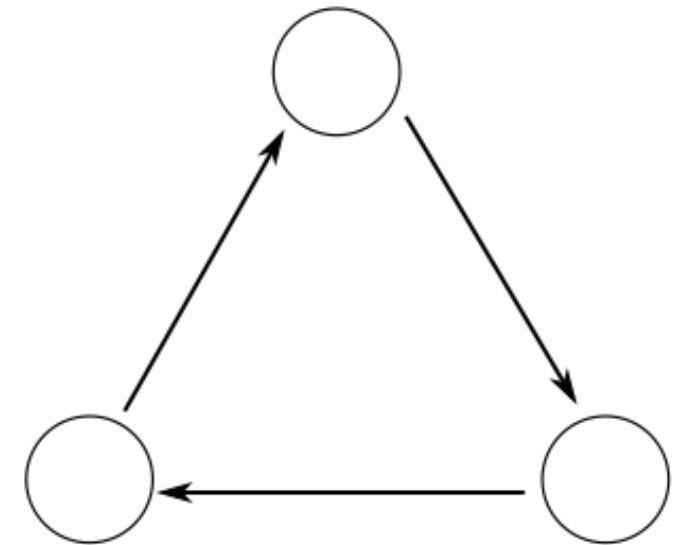
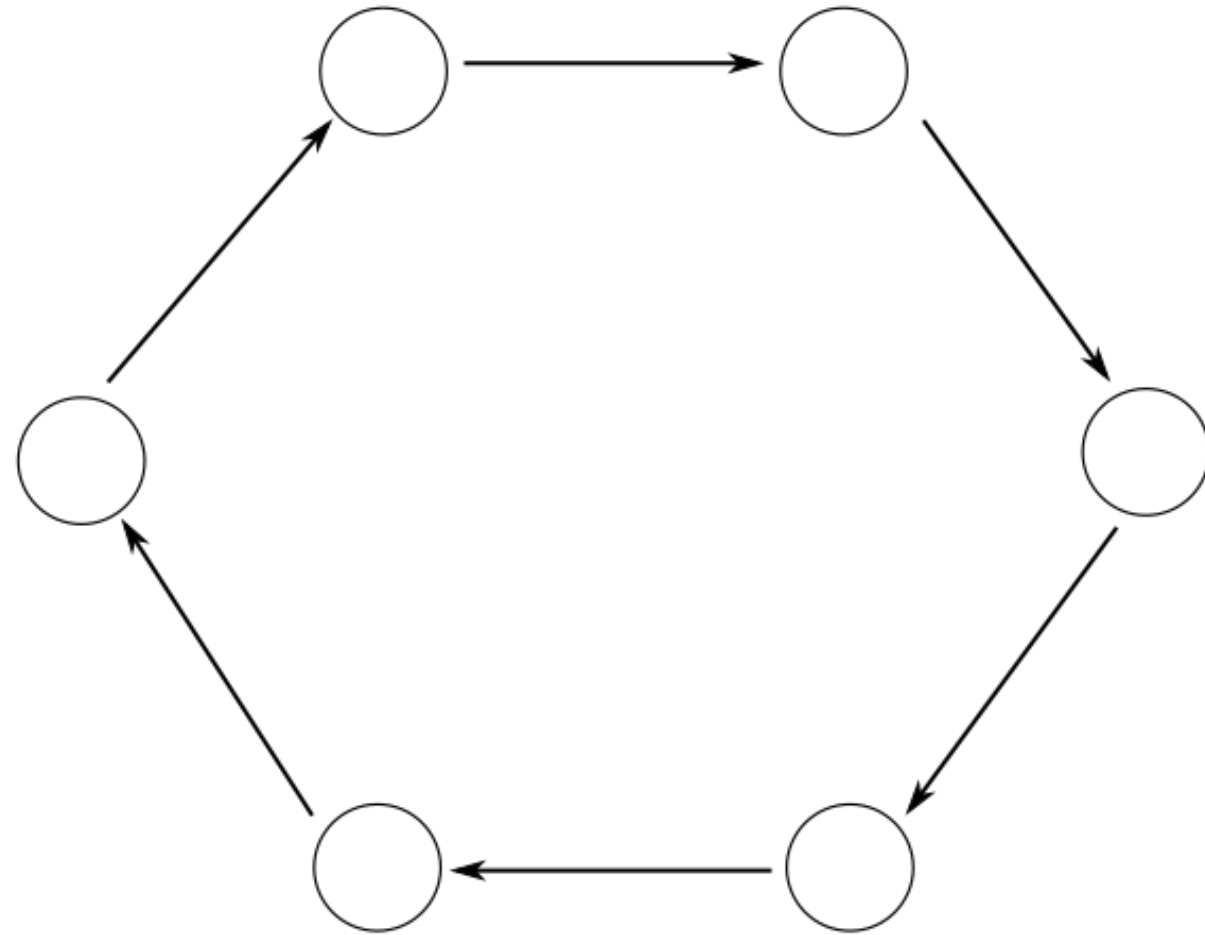

# Limitations of Kidney Exchange using TTCA



Long cycles can lead to **logistical problems**.





# Limitations of Kidney Exchange using TTCA



Long cycles can lead to **logistical problems**.

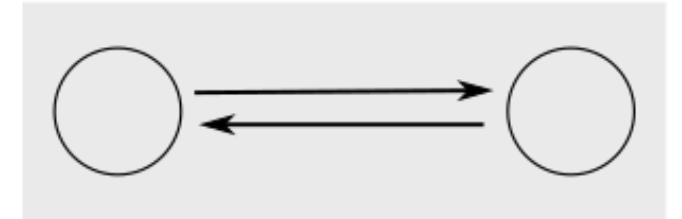
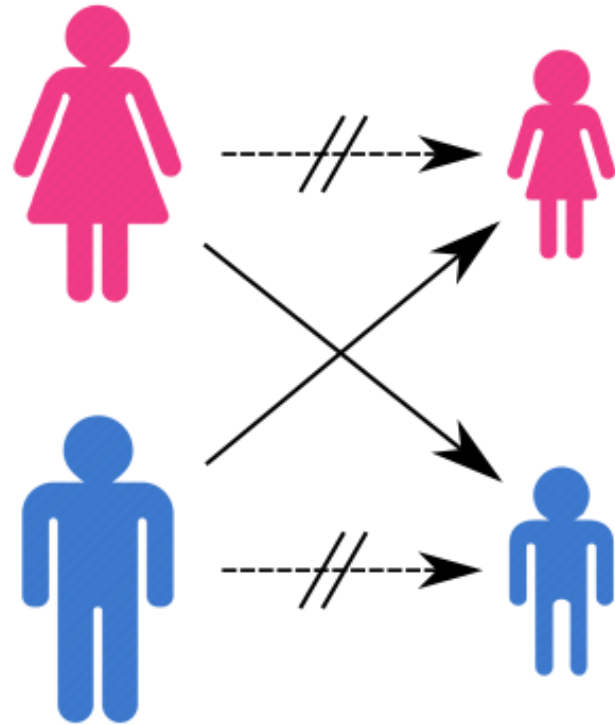

# Limitations of Kidney Exchange using TTCA



Long cycles can lead to **logistical problems**.

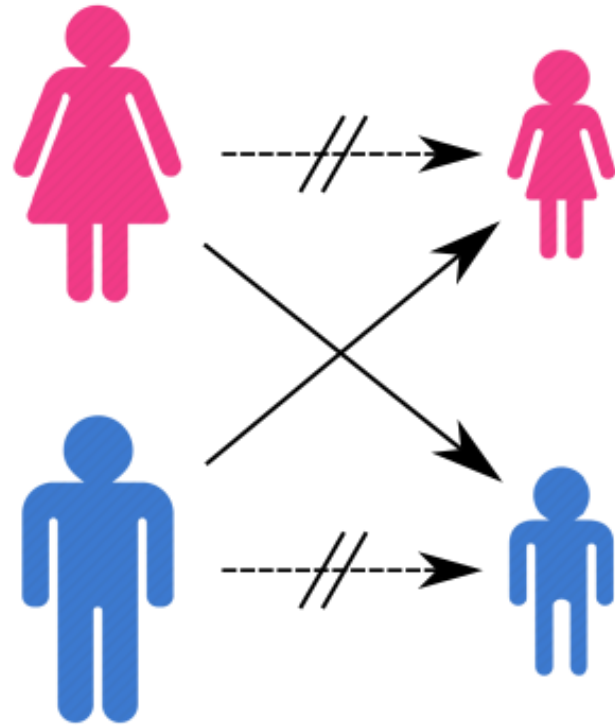

Four surgeries

# Limitations of Kidney Exchange using TTCA



Long cycles can lead to **logistical problems**.

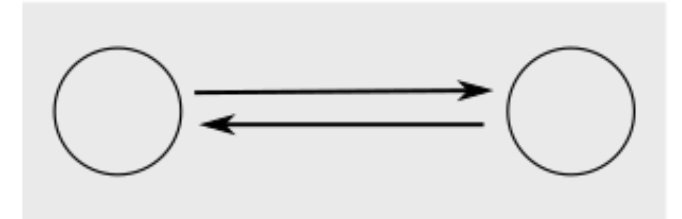
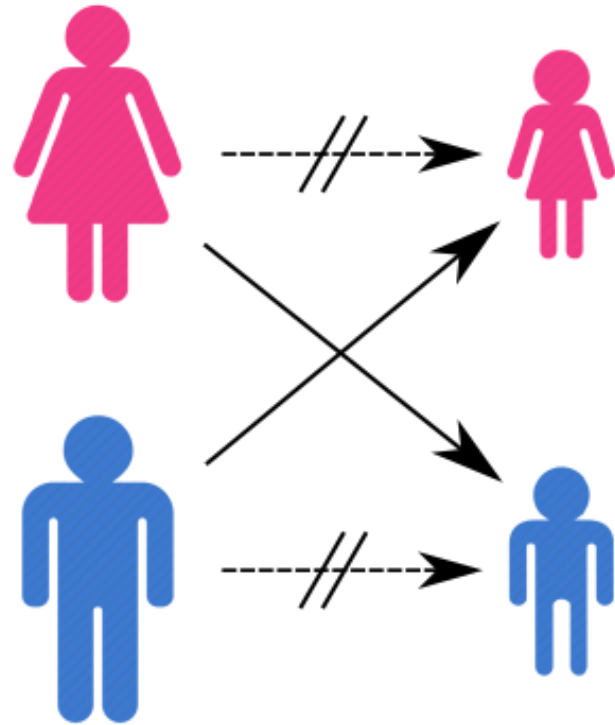

Four **simultaneous** surgeries

# Limitations of Kidney Exchange using TTCA



Long cycles can lead to **logistical problems**.

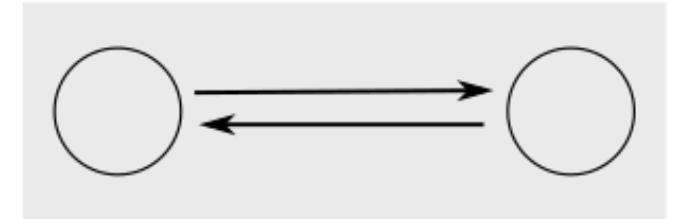
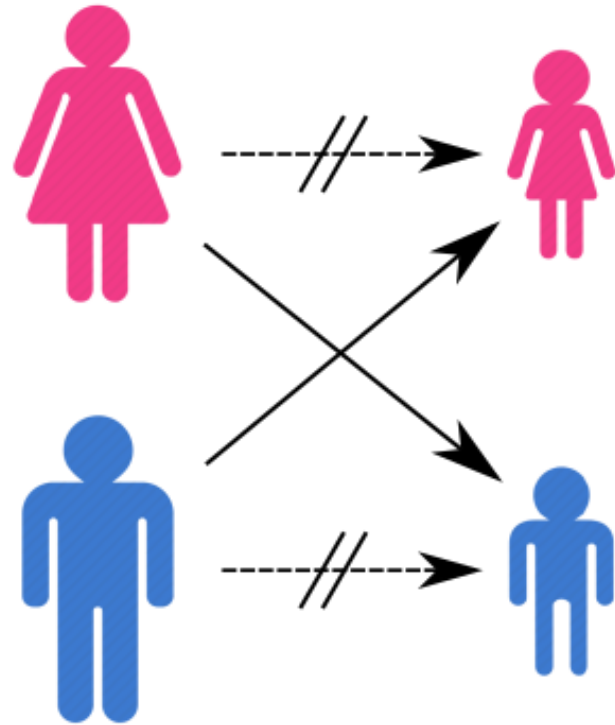

Four **simultaneous** surgeries

Cannot risk doing



# Limitations of Kidney Exchange using TTCA



Long cycles can lead to **logistical problems**.

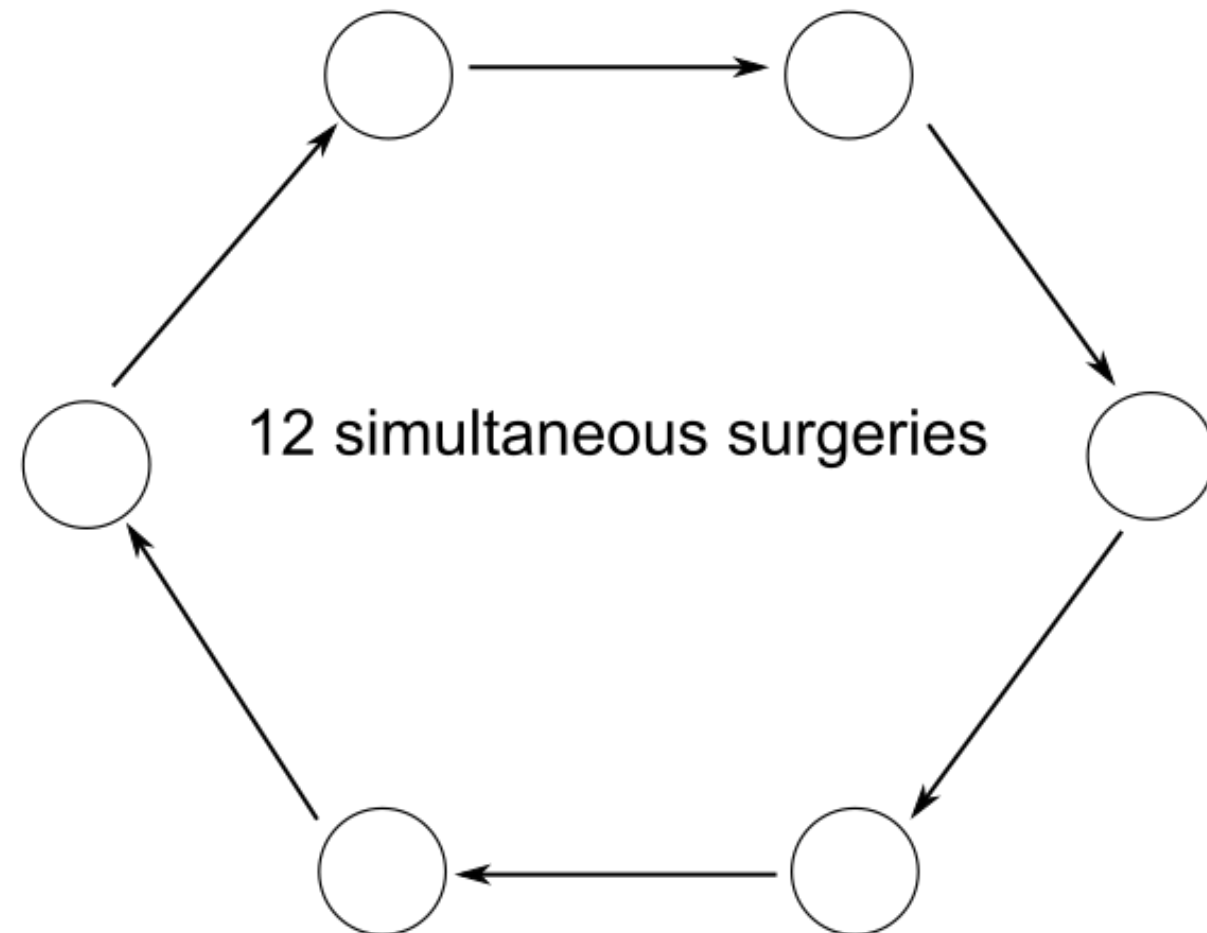

4 simultaneous surgeries

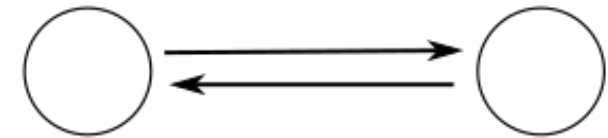

6 simultaneous surgeries

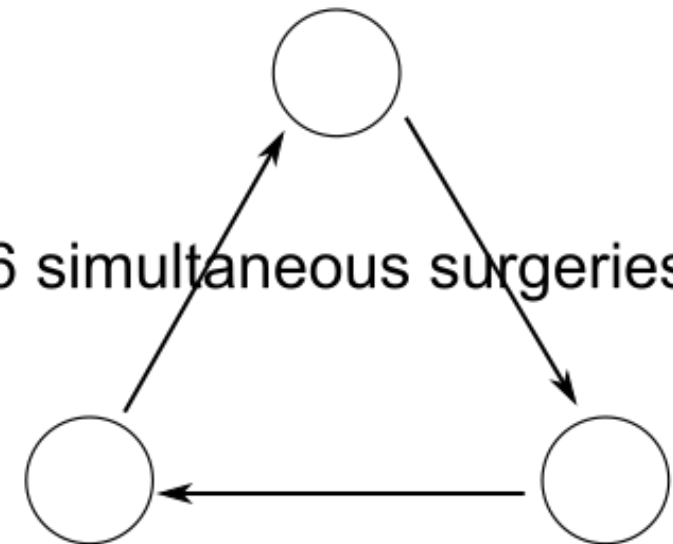

# Limitations of Kidney Exchange using TTCA

# Limitations of Kidney Exchange using TTCA



**Strict preferences** might be an overkill.

**Binary** preferences (compatible or incompatible) often suffice.

# Limitations of Kidney Exchange using TTCA



**Strict preferences** might be an overkill.

**Binary** preferences (compatible or incompatible) often suffice.

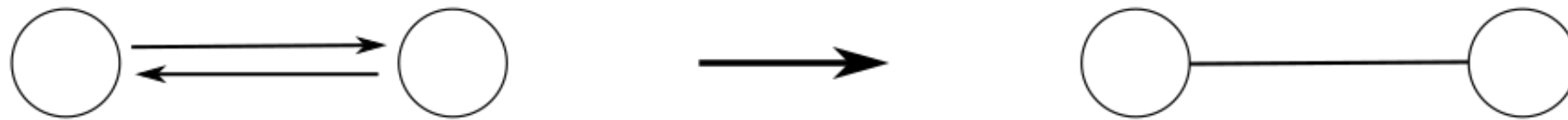



# Early Proposals for Kidney Exchange

Proposal 1

Using TTCA



Proposal 2



# Early Proposals for Kidney Exchange

Proposal 1

Using TTCA



Proposal 2

Using Matchings

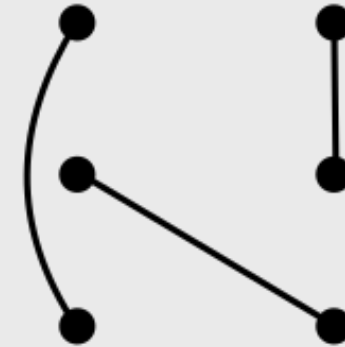

# Proposal 2: Kidney Exchange using Matchings

[Roth, Sönmez, and Ünver, *JET* 2005]

# Proposal 2: Kidney Exchange using Matchings

[Roth, Sönmez, and Ünver, *JET* 2005]

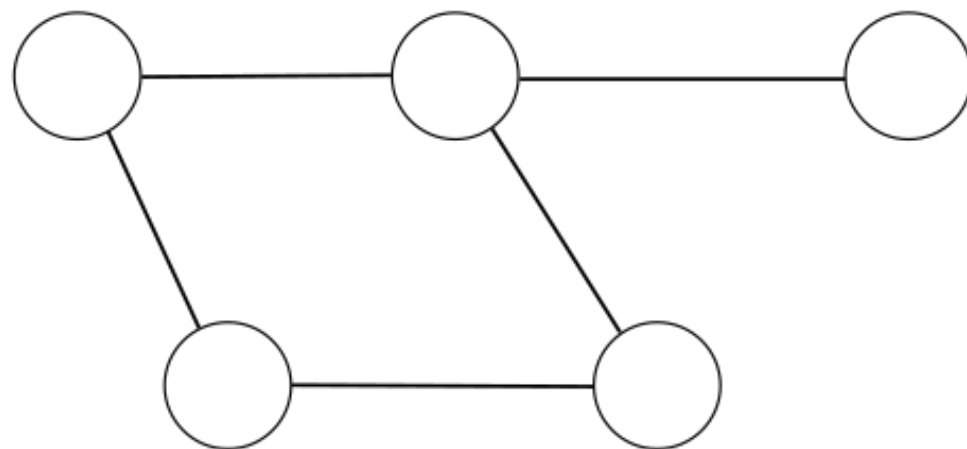

# Proposal 2: Kidney Exchange using Matchings

[Roth, Sönmez, and Ünver, *JET* 2005]

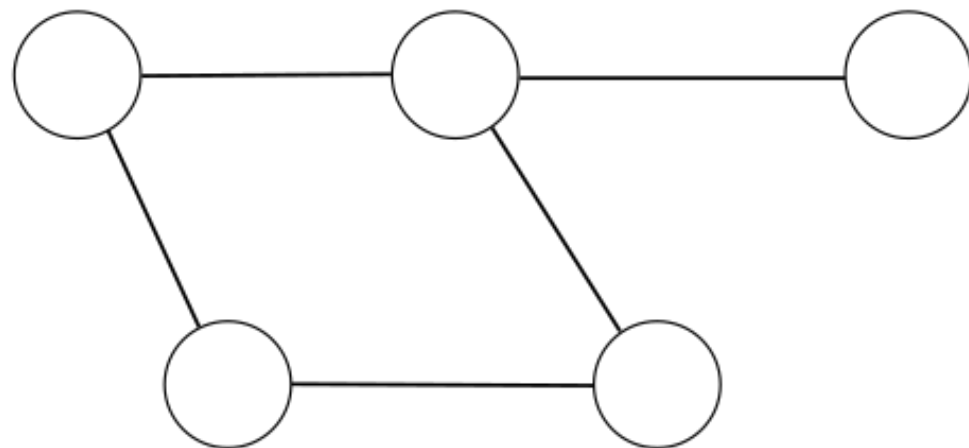

Given an undirected graph (of patient-donor pairs),  
find a maximum cardinality matching.

# Proposal 2: Kidney Exchange using Matchings

[Roth, Sönmez, and Ünver, *JET* 2005]

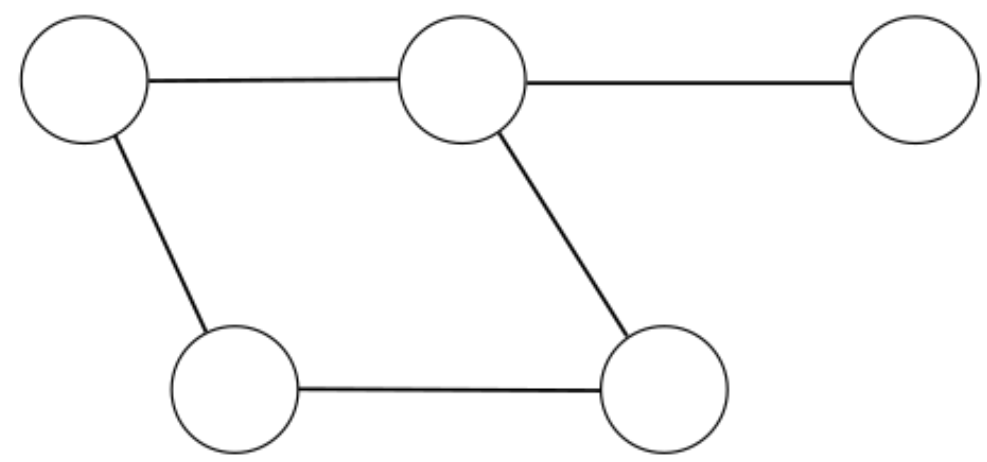

Given an undirected graph (of patient-donor pairs),  
find **a** maximum cardinality matching.

↖ underspecified (can lead to **incentive issues**)

# Proposal 2: Kidney Exchange using Matchings

[Roth, Sönmez, and Ünver, *JET* 2005]

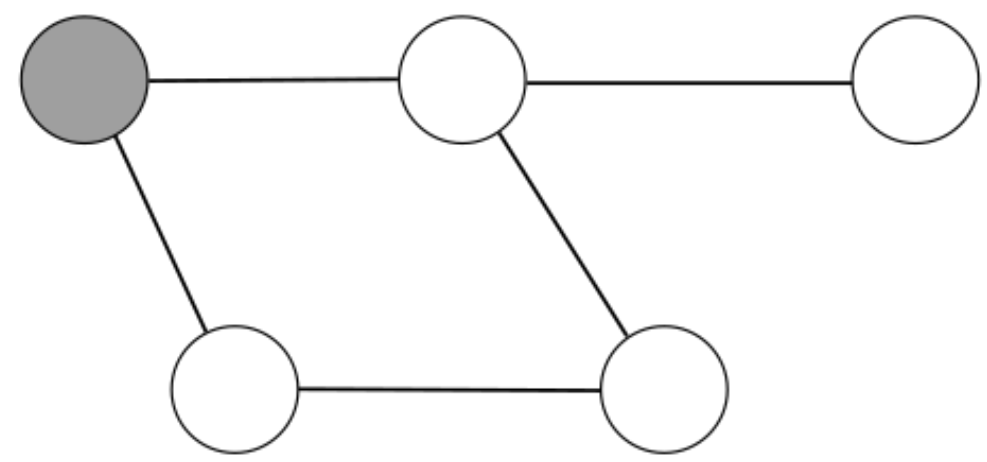

Given an undirected graph (of patient-donor pairs),  
find **a** maximum cardinality matching.

↖ underspecified (can lead to **incentive issues**)

# Proposal 2: Kidney Exchange using Matchings

[Roth, Sönmez, and Ünver, *JET* 2005]

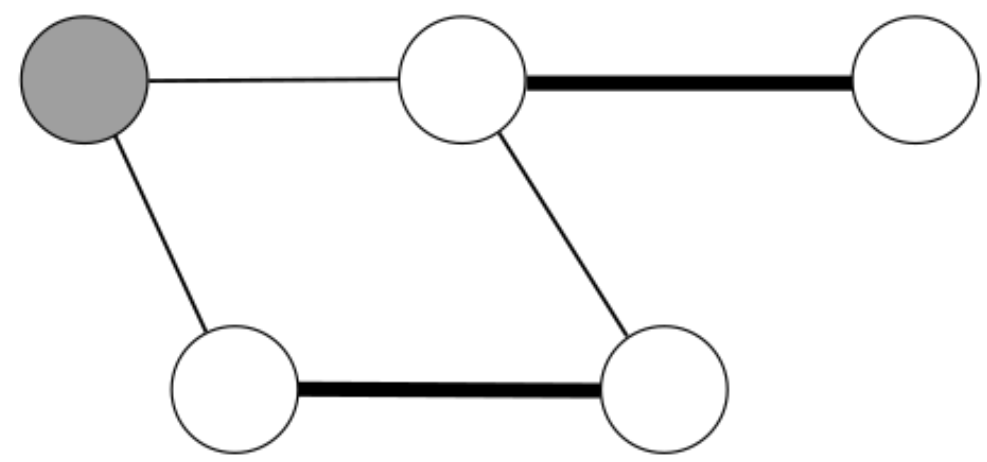

Given an undirected graph (of patient-donor pairs),  
find **a** maximum cardinality matching.

↖ underspecified (can lead to **incentive issues**)



# Proposal 2: Kidney Exchange using Matchings

[Roth, Sönmez, and Ünver, *JET* 2005]

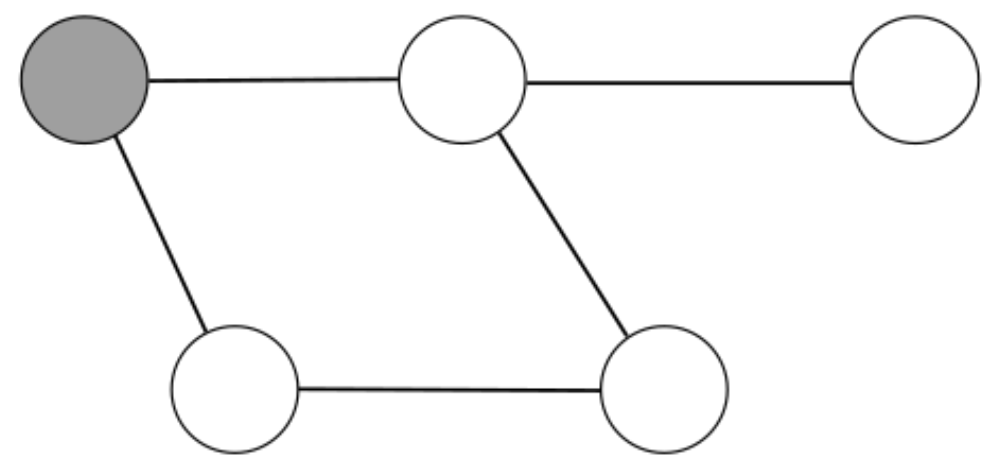

Given an undirected graph (of patient-donor pairs),  
find **a** maximum cardinality matching.

↖ underspecified (can lead to **incentive issues**)

# Proposal 2: Kidney Exchange using Matchings

[Roth, Sönmez, and Ünver, *JET* 2005]

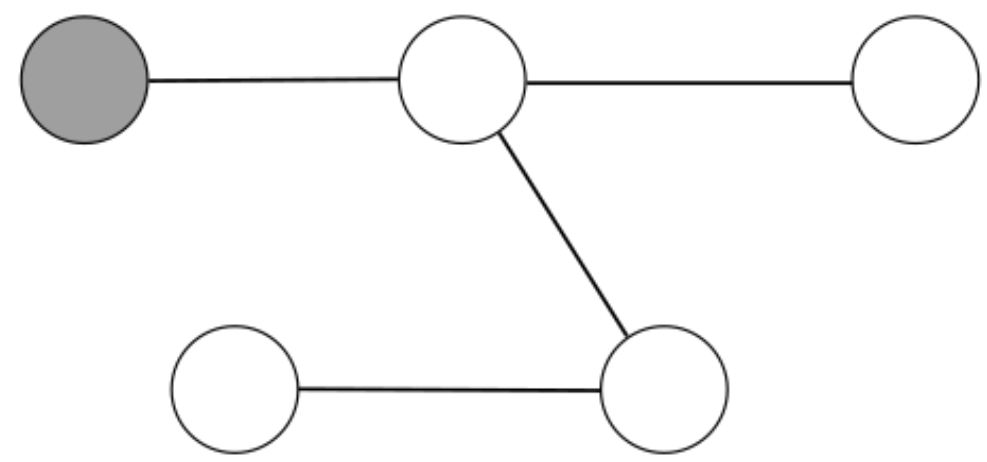

Given an undirected graph (of patient-donor pairs),  
find **a** maximum cardinality matching.

↖ underspecified (can lead to **incentive issues**)

# Proposal 2: Kidney Exchange using Matchings

[Roth, Sönmez, and Ünver, *JET* 2005]

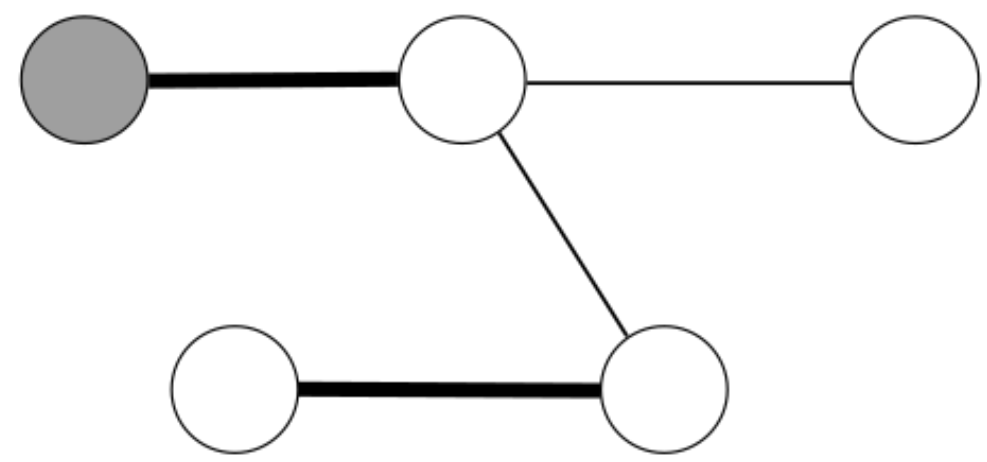

Given an undirected graph (of patient-donor pairs),  
find **a** maximum cardinality matching.

underspecified (can lead to **incentive issues**)

# Proposal 2: Kidney Exchange using Matchings

[Roth, Sönmez, and Ünver, *JET* 2005]

# Proposal 2: Kidney Exchange using Matchings

[Roth, Sönmez, and Ünver, *JET* 2005]

## Priority Mechanism



# Proposal 2: Kidney Exchange using Matchings

[Roth, Sönmez, and Ünver, *JET* 2005]

## Priority Mechanism

Consider a *priority ordering*  $1, 2, \dots, n$  over vertices (can't be misreported).

# Proposal 2: Kidney Exchange using Matchings

[Roth, Sönmez, and Ünver, *JET* 2005]

## Priority Mechanism

Consider a *priority ordering*  $1, 2, \dots, n$  over vertices (can't be misreported).

Let  $M_0$  be the set of **maximum matchings** of the given graph.

# Proposal 2: Kidney Exchange using Matchings

[Roth, Sönmez, and Ünver, *JET* 2005]

## Priority Mechanism

Consider a *priority ordering*  $1, 2, \dots, n$  over vertices (can't be misreported).

Let  $M_0$  be the set of **maximum matchings** of the given graph.

For  $i = 1, 2, \dots, n$ :



# Proposal 2: Kidney Exchange using Matchings

[Roth, Sönmez, and Ünver, *JET* 2005]

## Priority Mechanism

Consider a *priority ordering*  $1, 2, \dots, n$  over vertices (can't be misreported).

Let  $M_0$  be the set of **maximum matchings** of the given graph.

For  $i = 1, 2, \dots, n$ :

Let  $S_i$  be the set of matchings in  $M_{i-1}$  that match **vertex  $i$** .

# Proposal 2: Kidney Exchange using Matchings

[Roth, Sönmez, and Ünver, *JET* 2005]

## Priority Mechanism

Consider a *priority ordering*  $1, 2, \dots, n$  over vertices (can't be misreported).

Let  $M_0$  be the set of **maximum matchings** of the given graph.

For  $i = 1, 2, \dots, n$ :

Let  $S_i$  be the set of matchings in  $M_{i-1}$  that match **vertex  $i$** .

If  $S_i$  is non-empty, then  $M_i \leftarrow S_i$ . Otherwise,  $M_i \leftarrow M_{i-1}$ .

# Proposal 2: Kidney Exchange using Matchings

[Roth, Sönmez, and Ünver, *JET* 2005]

## Priority Mechanism

Consider a *priority ordering*  $1, 2, \dots, n$  over vertices (can't be misreported).

Let  $M_0$  be the set of **maximum matchings** of the given graph.

For  $i = 1, 2, \dots, n$ :

Let  $S_i$  be the set of matchings in  $M_{i-1}$  that match **vertex  $i$** .

If  $S_i$  is non-empty, then  $M_i \leftarrow S_i$ . Otherwise,  $M_i \leftarrow M_{i-1}$ .

return  $M_n$

# Advantages of Kidney Exchange using Matchings

# Advantages of Kidney Exchange using Matchings



Each matching in  $M_n$  matches the same set of vertices.

# Advantages of Kidney Exchange using Matchings



Each matching in  $M_n$  matches the same set of vertices.



No agent will "underreport" the set of its compatible edges.

# Advantages of Kidney Exchange using Matchings



Each matching in  $M_n$  matches the same set of vertices.



No agent will "underreport" the set of its compatible edges.



The resulting matching is **Pareto optimal**  
(no other matching can match a superset of the matched agents).

# Advantages of Kidney Exchange using Matchings



Each matching in  $M_n$  matches the same set of vertices.



No agent will "underreport" the set of its compatible edges.



The resulting matching is **Pareto optimal**  
(no other matching can match a superset of the matched agents).



Polynomial time  
(uses Edmonds-Gallai decomposition from Graph Theory)



# Limitations of Kidney Exchange using Matchings

# Limitations of Kidney Exchange using Matchings



As kidney exchange has evolved, the game has shifted.

It is the **hospitals**, and not the individual patient-donor pairs, that have become the new "players".

# Limitations of Kidney Exchange using Matchings



As kidney exchange has evolved, the game has shifted. It is the **hospitals**, and not the individual patient-donor pairs, that have become the new "players".

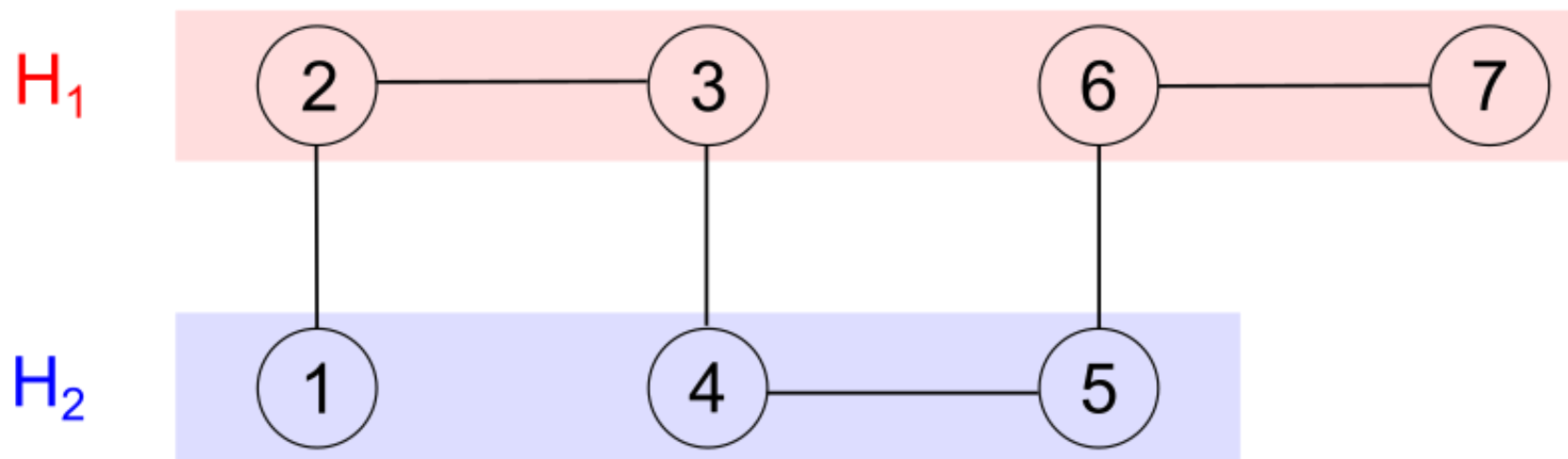

# Limitations of Kidney Exchange using Matchings



As kidney exchange has evolved, the game has shifted. It is the **hospitals**, and not the individual patient-donor pairs, that have become the new "players".

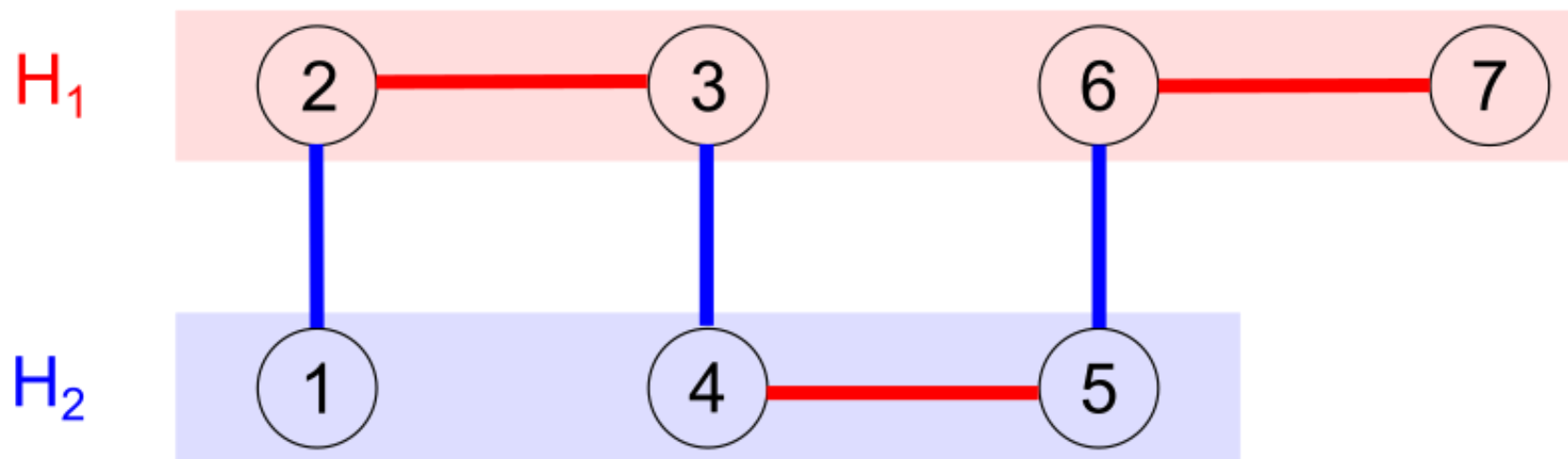

# Limitations of Kidney Exchange using Matchings



As kidney exchange has evolved, the game has shifted. It is the **hospitals**, and not the individual patient-donor pairs, that have become the new "players".

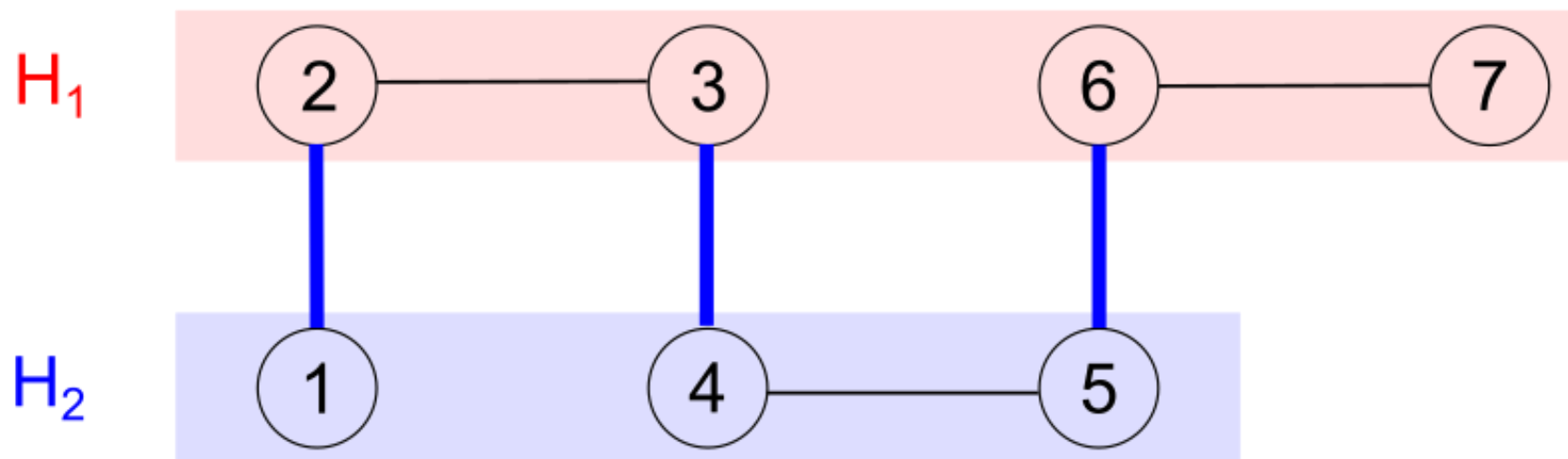

# Limitations of Kidney Exchange using Matchings



As kidney exchange has evolved, the game has shifted. It is the **hospitals**, and not the individual patient-donor pairs, that have become the new "players".

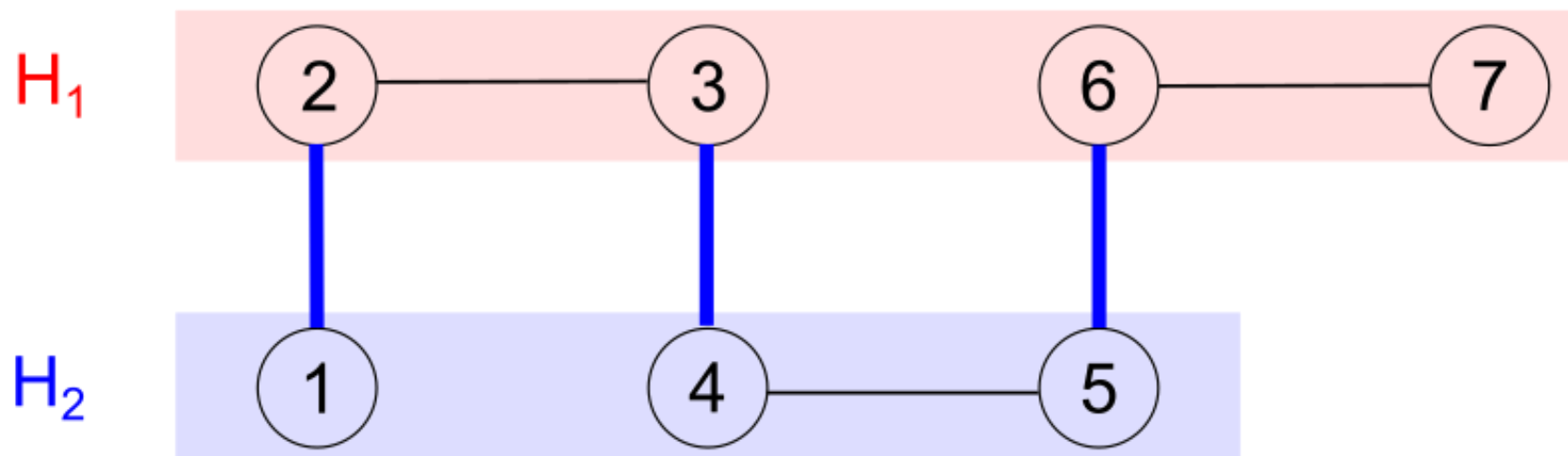

Hospital  $H_1$  can match (2) and (3) internally (i.e., not disclose these pairs to the matching algorithm) and have all of its patients matched.

# Limitations of Kidney Exchange using Matchings



As kidney exchange has evolved, the game has shifted. It is the **hospitals**, and not the individual patient-donor pairs, that have become the new "players".

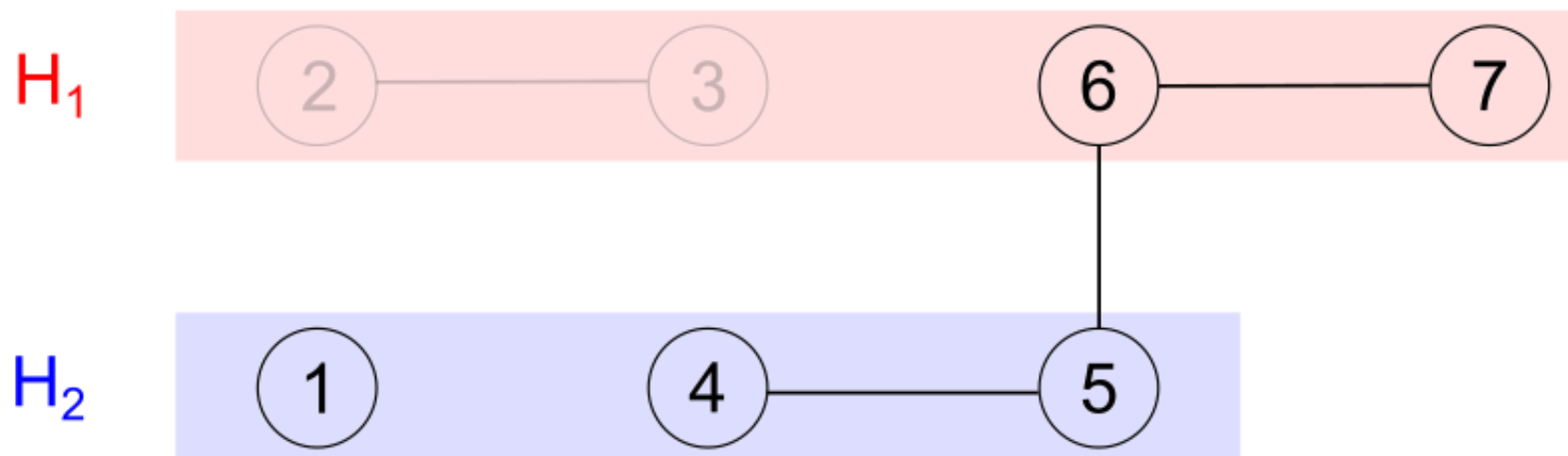

Hospital  $H_1$  can match (2) and (3) internally (i.e., not disclose these pairs to the matching algorithm) and have all of its patients matched.

# Limitations of Kidney Exchange using Matchings



As kidney exchange has evolved, the game has shifted. It is the **hospitals**, and not the individual patient-donor pairs, that have become the new "players".

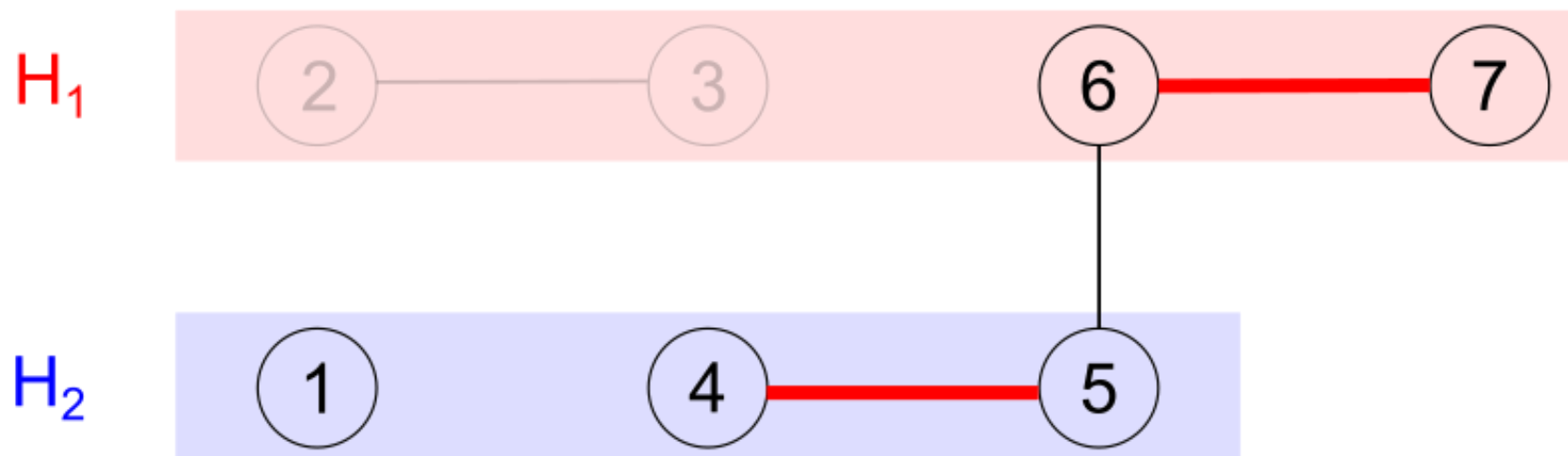

Hospital  $H_1$  can match (2) and (3) internally (i.e., not disclose these pairs to the matching algorithm) and have all of its patients matched.



# Limitations of Kidney Exchange using Matchings



As kidney exchange has evolved, the game has shifted. It is the **hospitals**, and not the individual patient-donor pairs, that have become the new "players".

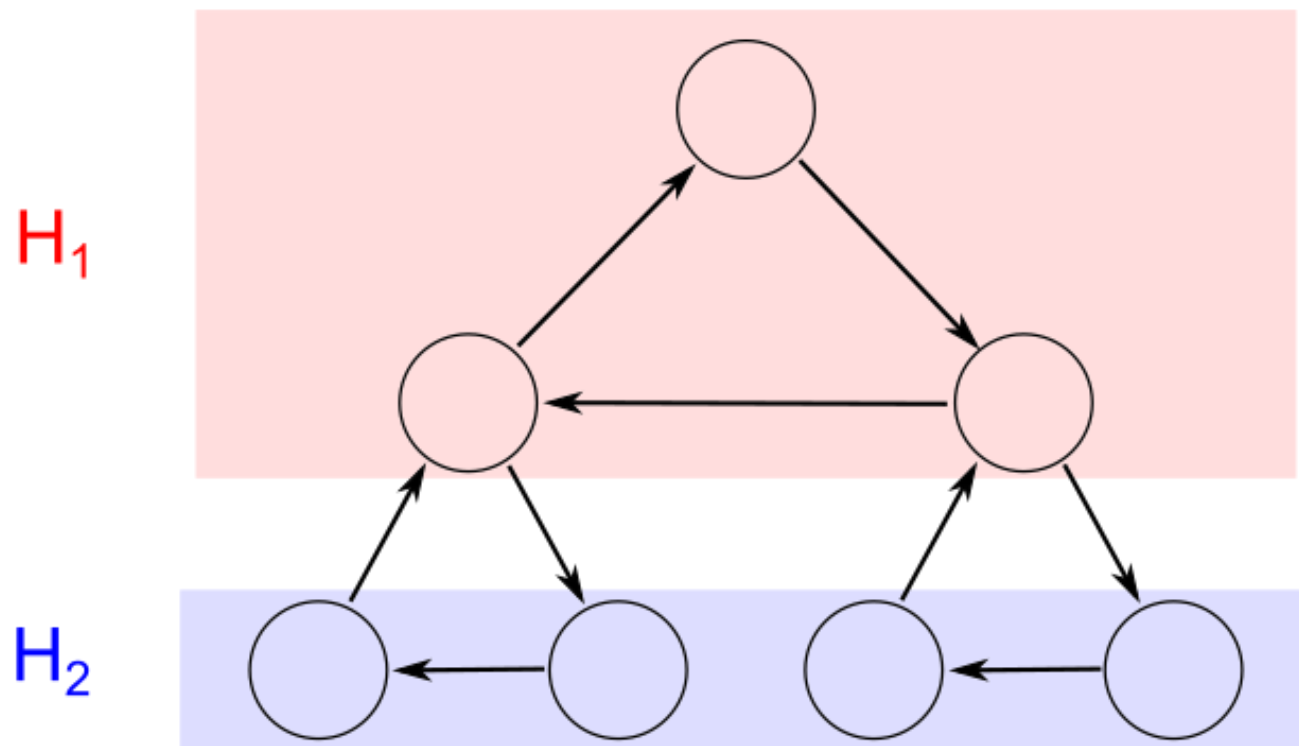

# Limitations of Kidney Exchange using Matchings



As kidney exchange has evolved, the game has shifted. It is the **hospitals**, and not the individual patient-donor pairs, that have become the new "players".

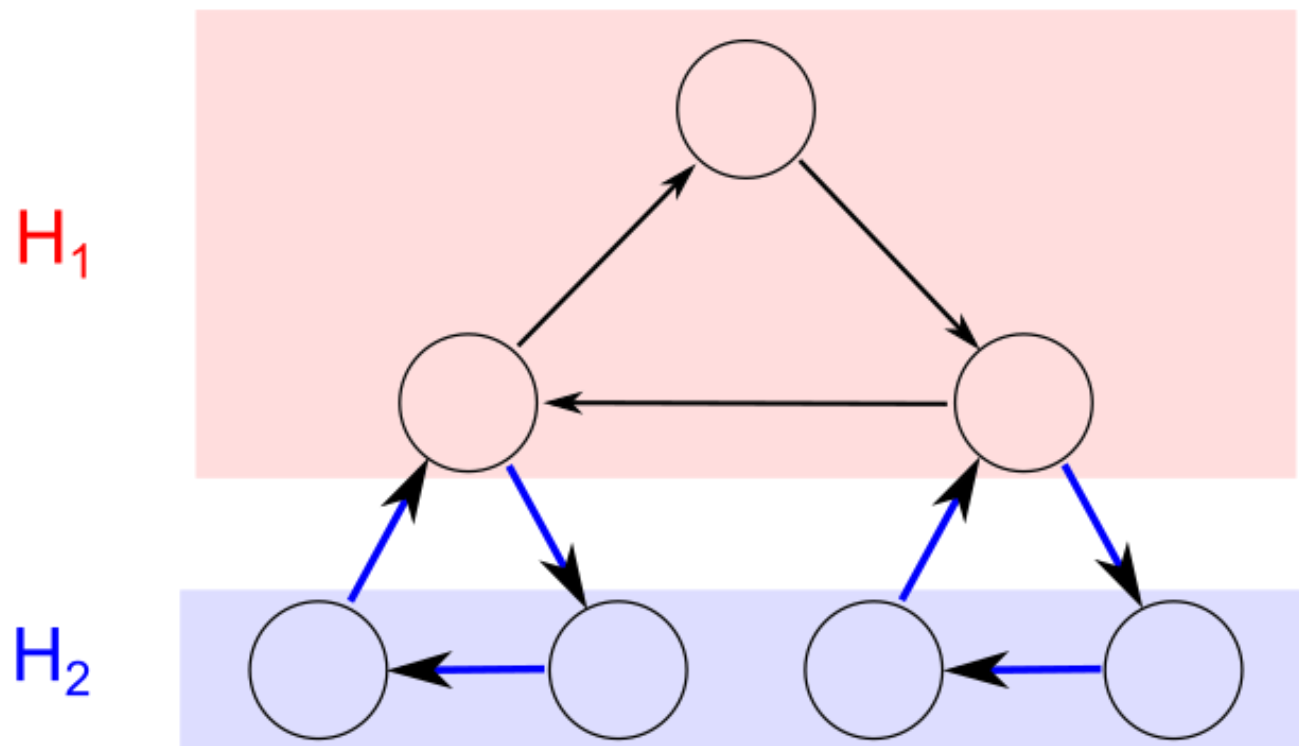

# Limitations of Kidney Exchange using Matchings



As kidney exchange has evolved, the game has shifted. It is the **hospitals**, and not the individual patient-donor pairs, that have become the new "players".

$H_1$

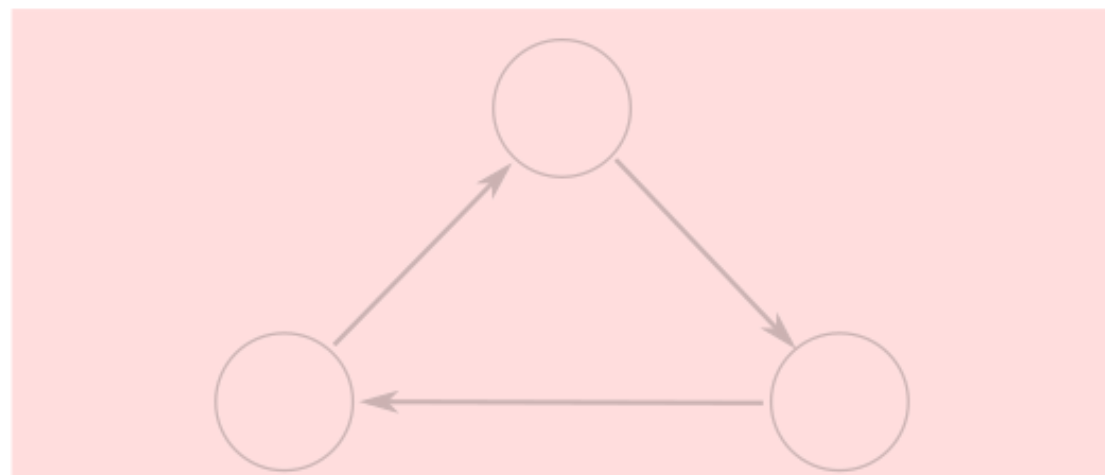

$H_2$

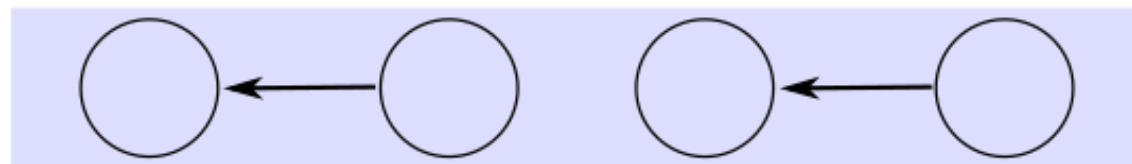

## History [\[ edit \]](#)

Year	Event
1986	KPD first suggested by Rapaport <sup>[14]</sup>
1991	First KPD program started in South Korea by Dr. Park <sup>[8]</sup>
1999	First European KPD transplants performed in Switzerland <sup>[8]</sup>
2000	First KPD transplants performed in USA at the Rhode Island Hospital <sup>[8]</sup>
2001	Hopkins completes KPD transplants and begins first KPD program in USA <sup>[15]</sup>
2004	Dutch established first national KPD program <sup>[8]</sup>
2007	NEAD chain started by APD utilizing first bridge donor <sup>[16]</sup>
2007	Charlie Norwood Living Organ Donation Act clarifies legality of KPD in USA <sup>[17]</sup>
2008	National Kidney Registry organizes its first transplants on Valentine's Day <sup>[18]</sup>
2009	Hopkins leads first 16 patient multicenter Domino Chain <sup>[19][20]</sup>
2010	UNOS organizes its first KPD transplants <sup>[8]</sup>
2012	National Kidney Registry completes largest chain involving 60 participants <sup>[6]</sup>
2014	National Kidney Registry sets new record with 70 participant chain <sup>[7]</sup>
2017	First Academic Paper published on "Chronological Incompatibility" outlining the ADP Voucher Program" <sup>[21]</sup>

## History [\[ edit \]](#)

Year	Event
1986	KPD first suggested by Rapaport <sup>[14]</sup>
1991	First KPD program started in South Korea by Dr. Park <sup>[8]</sup>
1999	First European KPD transplants performed in Switzerland <sup>[8]</sup>
2000	First KPD transplants performed in USA at the Rhode Island Hospital <sup>[8]</sup>
2001	Hopkins completes KPD transplants and begins first KPD program in USA <sup>[15]</sup>
2004	Dutch established first national KPD program <sup>[8]</sup>
2007	NEAD chain started by APD utilizing first bridge donor <sup>[16]</sup>
2007	Charlie Norwood Living Organ Donation Act clarifies legality of KPD in USA <sup>[17]</sup>
2008	National Kidney Registry organizes its first transplants on Valentine's Day <sup>[18]</sup>
2009	Hopkins leads first 16 patient multicenter Domino Chain <sup>[19][20]</sup>
2010	UNOS organizes its first KPD transplants <sup>[8]</sup>
2012	National Kidney Registry completes largest chain involving 60 participants <sup>[6]</sup>
2014	National Kidney Registry sets new record with 70 participant chain <sup>[7]</sup>
2017	First Academic Paper published on "Chronological Incompatibility" outlining the ADP Voucher Program" <sup>[21]</sup>

# Altruistic Donors and Chains

# Altruistic Donors and Chains

Donors who want to donate an organ without a designated recipient  
(also known as a *non-directed* or *Good Samaritan* donor)

# Altruistic Donors and Chains

Donors who want to donate an organ without a designated recipient  
(also known as a *non-directed* or *Good Samaritan* donor)

waiting list





# Altruistic Donors and Chains

Donors who want to donate an organ without a designated recipient  
(also known as a *non-directed* or *Good Samaritan* donor)

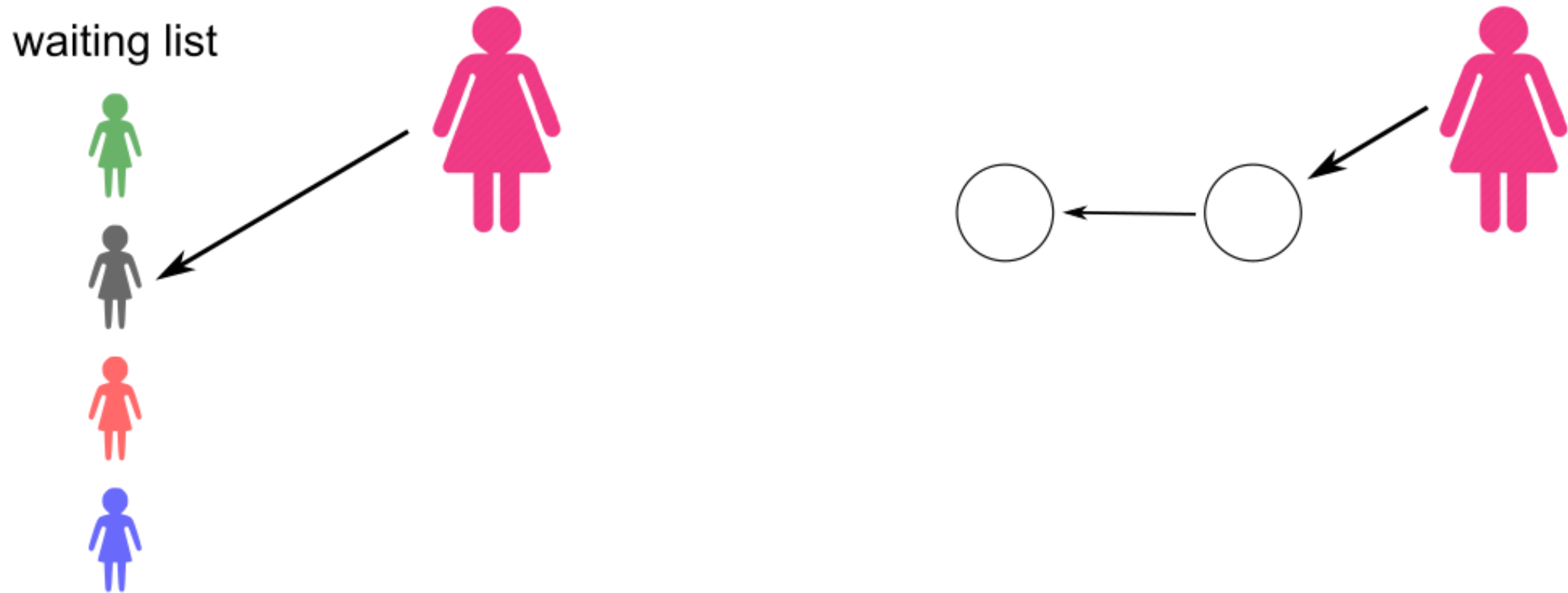

# Altruistic Donors and Chains

Donors who want to donate an organ without a designated recipient  
(also known as a *non-directed* or *Good Samaritan* donor)

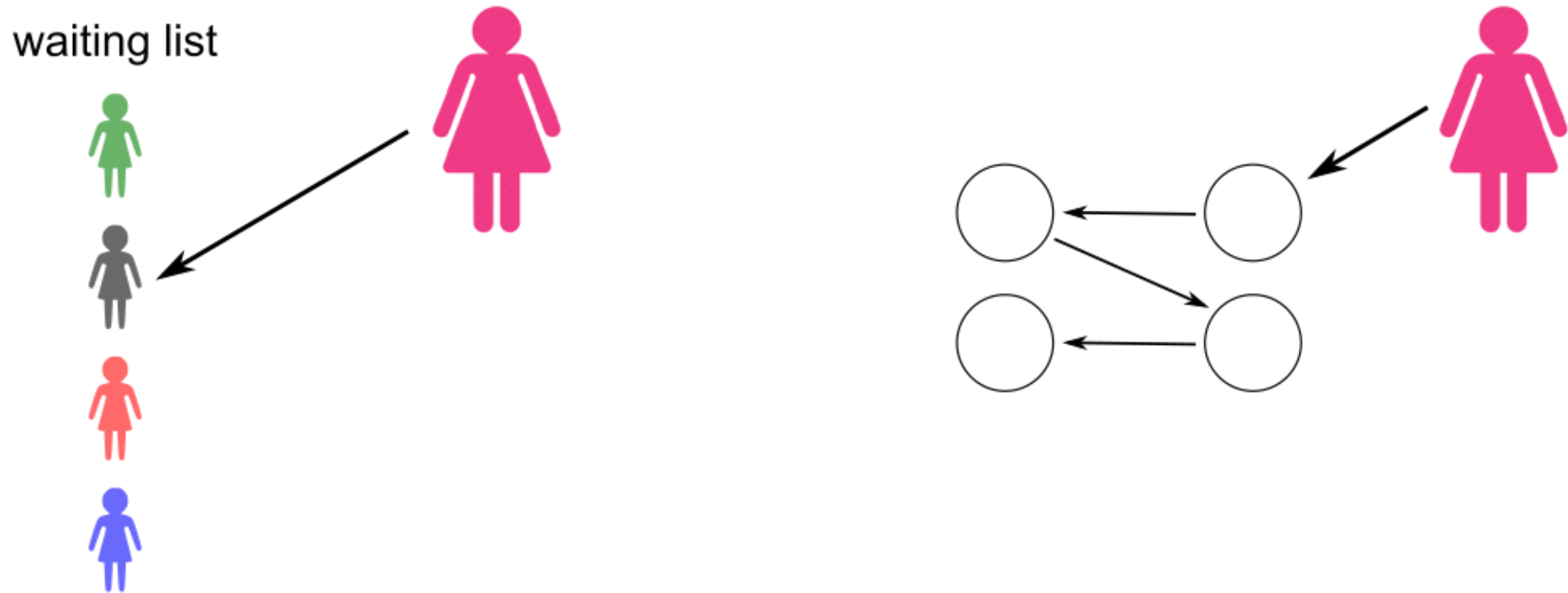

# Altruistic Donors and Chains

Donors who want to donate an organ without a designated recipient  
(also known as a *non-directed* or *Good Samaritan* donor)

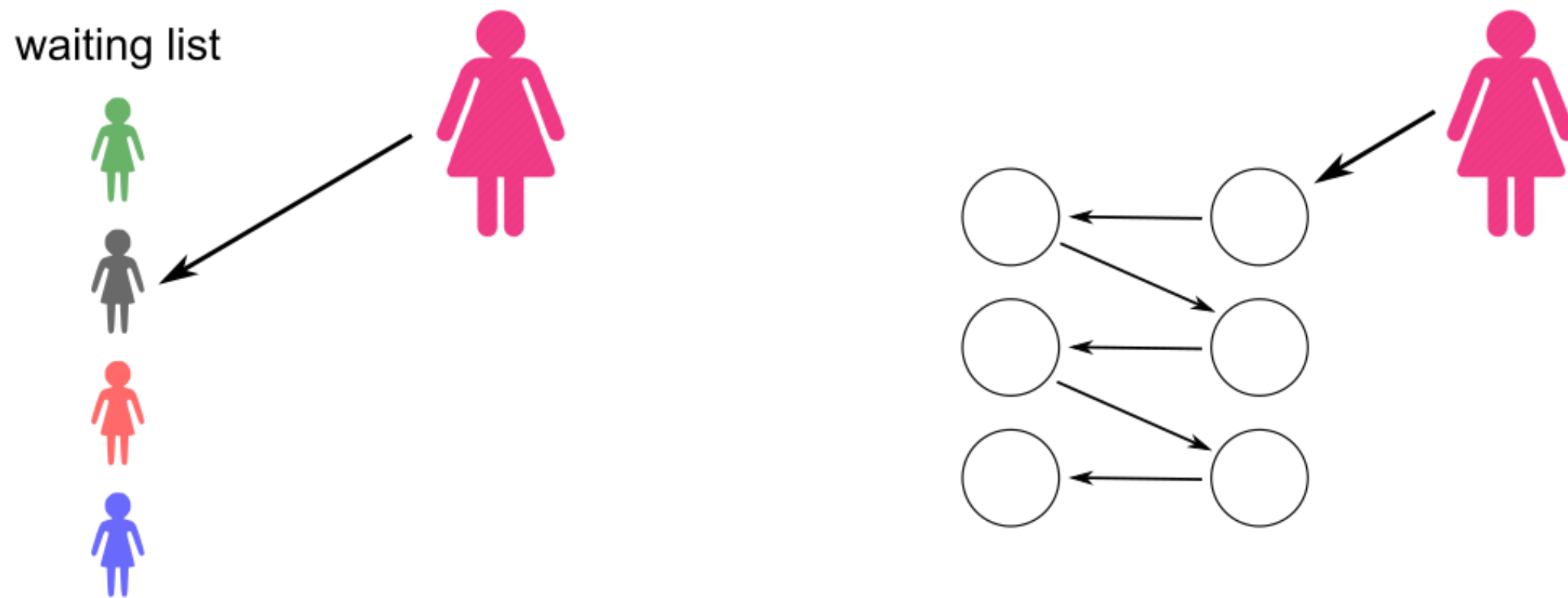

# Altruistic Donors and Chains

Donors who want to donate an organ without a designated recipient  
(also known as a *non-directed* or *Good Samaritan* donor)

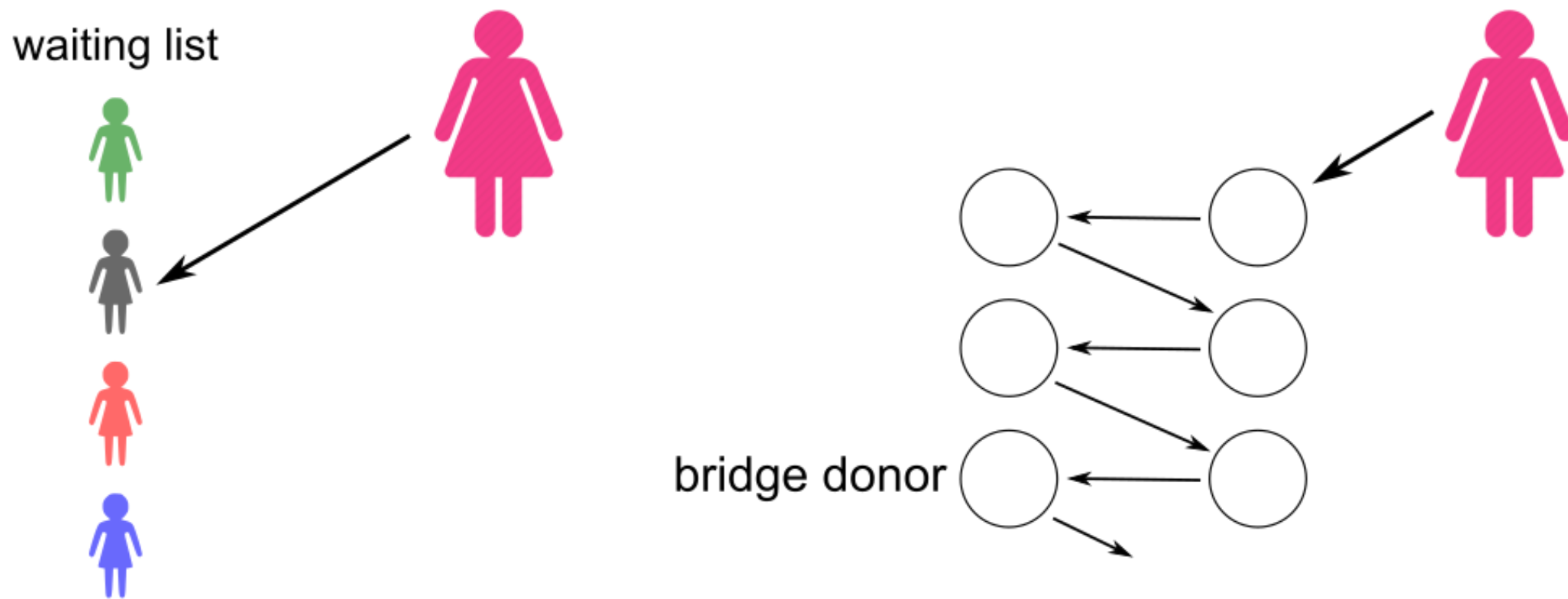

# Altruistic Donors and Chains

Donors who want to donate an organ without a designated recipient  
(also known as a *non-directed* or *Good Samaritan* donor)

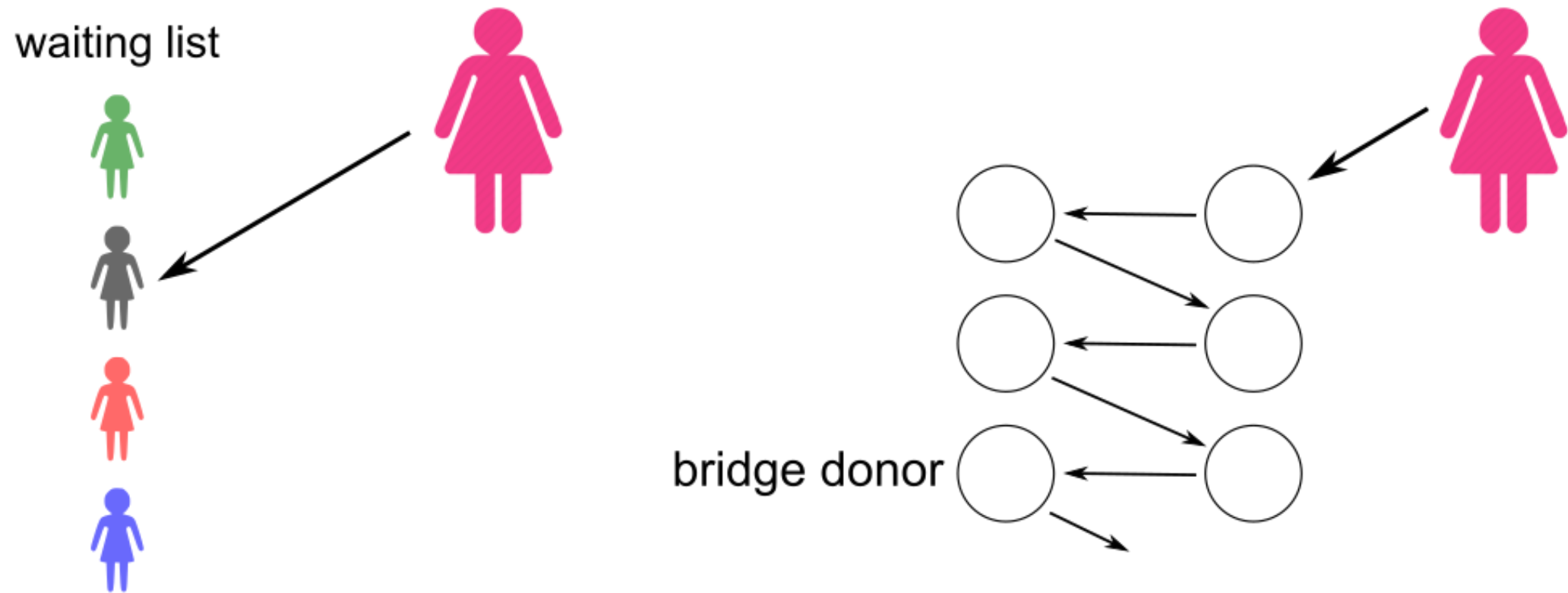

Transplants in an altruistic donor chain can be done **non-simultaneously**.



# THE KIDNEY CHAIN

How a single organ donation changed 20 lives and created the longest-running transplant chain



**MATT JONES, 30**  
Petoskey, Mich.  
First donor

donated to



**BARBARA BUNNELL, 56**  
Phoenix

married to



**RON BUNNELL, 56**  
Phoenix

donated to



**ANGELA HECKMAN, 34**  
Toledo, Ohio

daughter of



**LAURIE SARVO, 54**  
Toledo, Ohio

donated to



**REYNALDO ESPINOZA, 59**  
Germantown, Md.

donated to



**CLAUDIA ALAS, 32**  
Germantown, Md.

daughter of



**JEAN STAYLOR, 53**  
Charleston, S.C.

donated to



**RAYMOND STAYLOR, 53**  
Charleston, S.C.

married to



**AVA ROBY, 54**  
Marysville, Ohio

donated to



**GEORGE LEONER, 51**  
Chillicothe, Ohio

brother of



**LINDA JANISIESKI, 42**  
Miamisburg, Ohio

donated to



**CECILIA JANISIESKI, 71**  
Huber Heights, Ohio

mother of



**ANONYMOUS RECIPIENT**

married to



**ANONYMOUS DONOR**

donated to



**BILL CORAM, 55**  
Lincolnton, N.C.

friend of



**TIM SHAIN, 43**  
Lincolnton, N.C.

donated to



**LINLEY BLENKENSOPP, 51**  
Patchogue, N.Y.

brother of



**KURT BLENKENSOPP, 41**  
Patchogue, N.Y.

donated to



**KATHERINE MCKINNEY, 62**  
Toledo, Ohio

mother of



**HELEENA MCKINNEY, 29**  
Cincinnati  
Donor-in-waiting

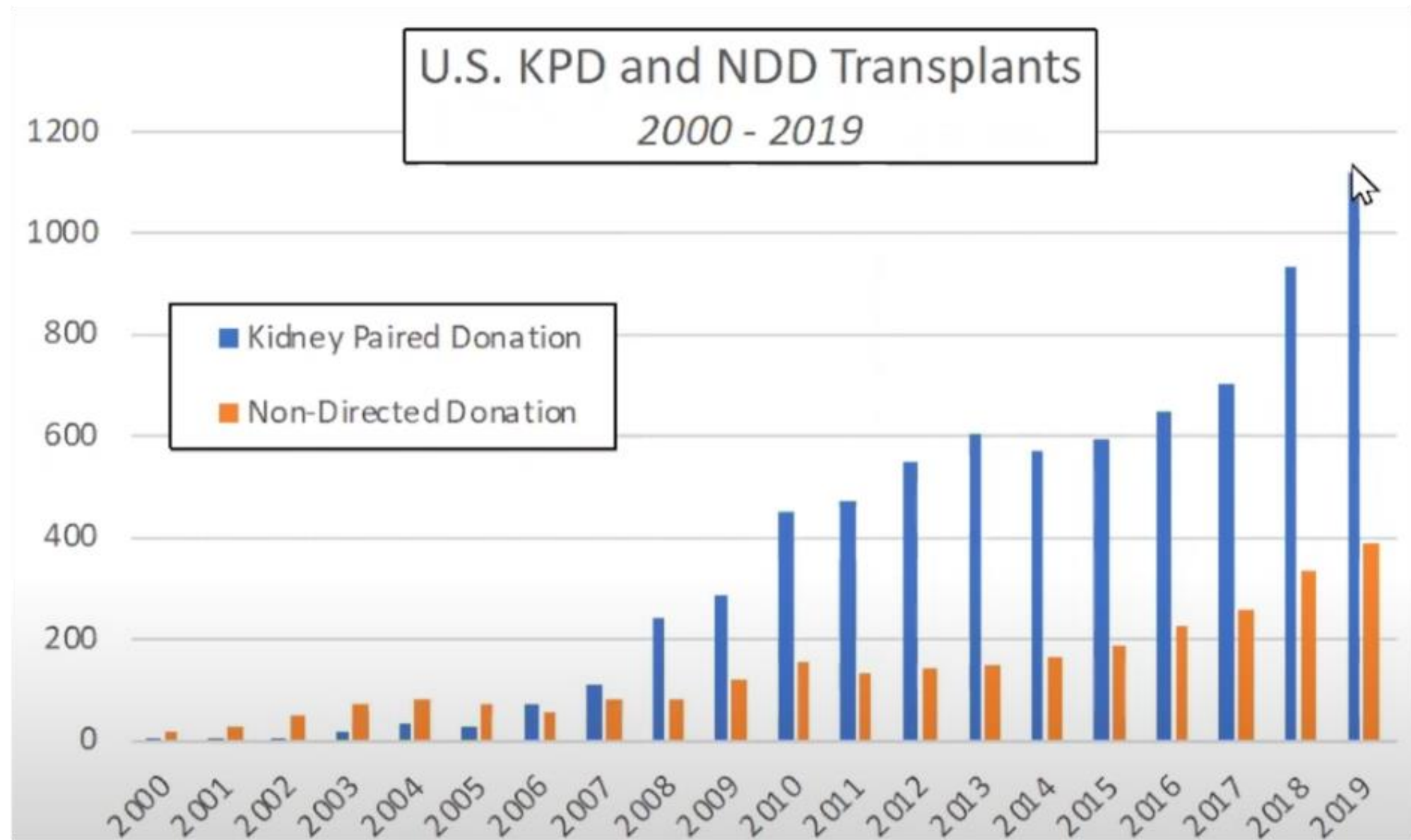
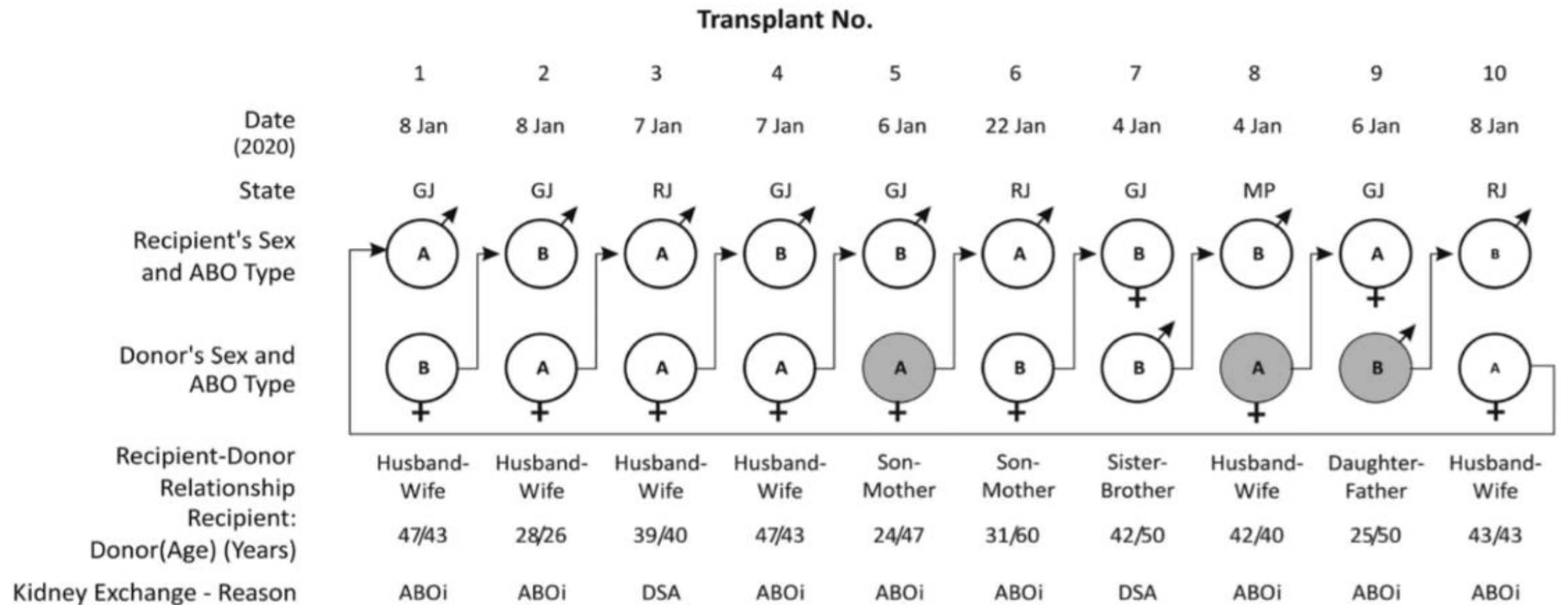

Figure source: Talk by Alvin Roth on "*Kidney Exchange: An Operations Perspective*" hosted by INFORMS Health Applications Society; June 2021



**FIGURE 1.** A nonsimultaneous 10-way kidney exchange cycle. GJ, Gujarat; MP, Madhya Pradesh; RJ, Rajasthan.



# Sveriges Riksbank Prize in Economic Sciences in Memory of Alfred Nobel 2012



Alvin E. Roth

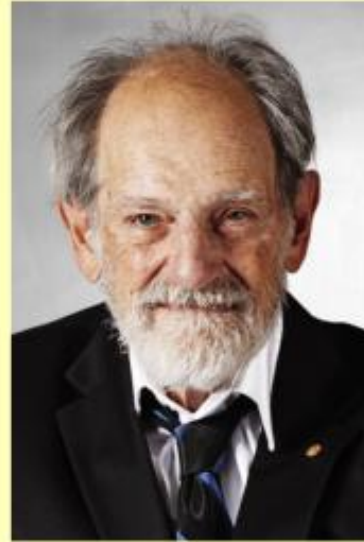

Lloyd S. Shapley

*"for the theory of stable allocations  
and the practice of market design."*

# Challenges in Kidney Exchange

**Economic:** Incentives of hospitals vs maximizing overall welfare.

**Computational:** Finding a maximum matching using 3-cycles is NP-hard.

**Informational:** Patients and donors arrive sequentially.

**Logistical:** Long cycles require many simultaneous surgeries.

**Legal:** Many countries do not permit altruistic donation.

**Ethical:** Is it OK to buy and sell kidneys?

# Next Time

## Stable Matchings

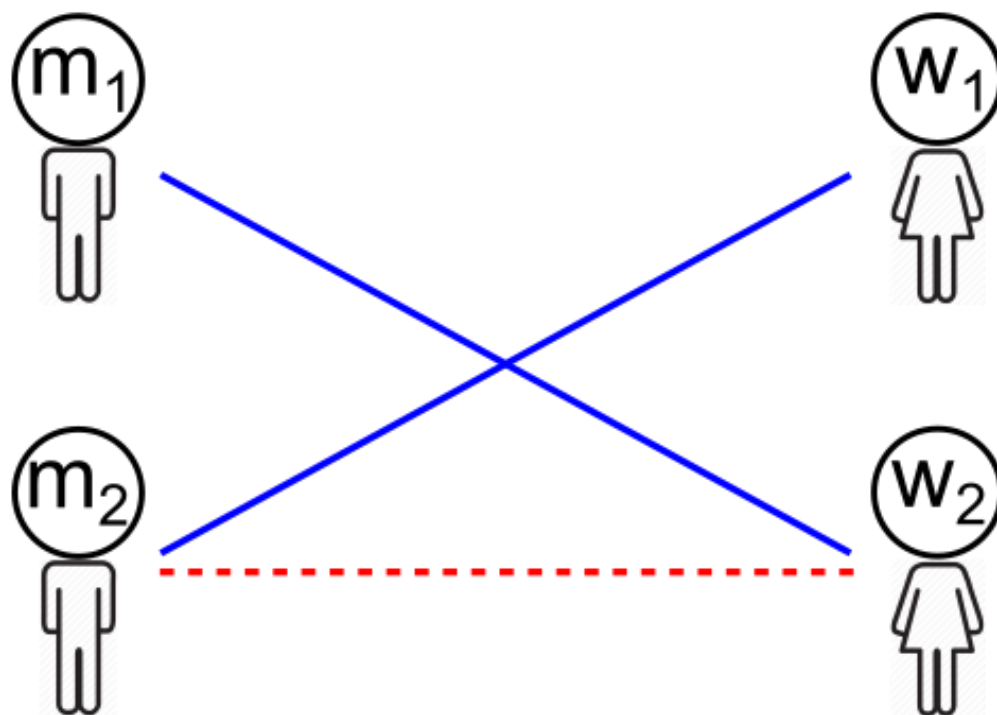

Reminder: **Project topics due today!**

# References

- Housing markets and TTCA

Lloyd Shapley and Herbert Scarf

*“On Cores and Indivisibility”*

Journal of Mathematical Economics, 1(1), 1974 pg 23-37

<https://www.sciencedirect.com/science/article/pii/0304406874900330>

- Truthfulness under TTCA

Alvin E. Roth

*“Incentive Compatibility in a Market with Indivisible Goods”*

Economics Letters, 9(2), 1982, pg 127-132

<https://www.sciencedirect.com/science/article/pii/0165176582900039>

# References

- The presentation is heavily inspired from Tim Roughgarden's lectures in the course on Algorithmic Game Theory (Fall 2013); see Lec 9 and 10.  
<https://timroughgarden.org/f13/f13.html>
- Data about waiting list for organs in the US:  
<https://optn.transplant.hrsa.gov/data/>
- Data about waiting list for kidneys in India (April 2019):  
<https://www.narayanahealth.org/blog/kidney-transplants-in-india/>
- Wikipedia article on “Kidney Paired Donation”:  
[https://en.wikipedia.org/wiki/Kidney\\_paired\\_donation](https://en.wikipedia.org/wiki/Kidney_paired_donation)

# References

- Proposal 1: Kidney exchange using top-trading cycles and chains

Alvin E. Roth, Tayfun Sönmez, and Utku Ünver  
*“Kidney Exchange”*

The Quarterly Journal of Economics, 119(2), 2004 pg 457-488

<https://academic.oup.com/qje/article/119/2/457/1894508>

- Proposal 2: Kidney exchange using matchings

Alvin E. Roth, Tayfun Sönmez, and Utku Ünver  
*“Pairwise Kidney Exchange”*

Journal of Economic Theory, 125(2), 2005 pg 151-188

<https://www.sciencedirect.com/science/article/pii/S0022053105001055>

# References

- The “*You request my house, I get your turn*” extension of TTCA was originally proposed in the context of dormitory assignment:

Atila Abdulkadiroğlu and Tayfun Sönmez

“*House Allocation with Existing Tenants*”

Journal of Economic Theory, 88(2), 1999 pg 233-260

<https://www.sciencedirect.com/science/article/pii/S002205319992553X#>

- Altruistic donor chains:

Rees et al.

“*A Non-Simultaneous, Extended, Altruistic Donor Chain*”

The New England Journal of Medicine, 360(11), 2009 pg 1096-1101

<https://www.nejm.org/doi/full/10.1056/NEJMoa0803645>



# References

- Videos, podcasts, and blogs:

<https://freakonomics.com/podcast/make-me-a-match/>  
<https://www.donordiaries.com/>

[https://www.youtube.com/watch?v=D3\\_0Bc7gbGA](https://www.youtube.com/watch?v=D3_0Bc7gbGA)  
<https://www.youtube.com/watch?v=exB1O3pTf7E>  
<https://www.youtube.com/watch?v=4NbJTcfN6UA>  
<https://www.donordiaries.com/episodes>

<http://marketdesigner.blogspot.com/search/label/kidney%20exchange>

